

**FIAT**  
**850**  
**SPORT**  
**SPIDER**

*North American Version*

1972 Fiat

1972 Fiat

**1972**  
**owner's manual**

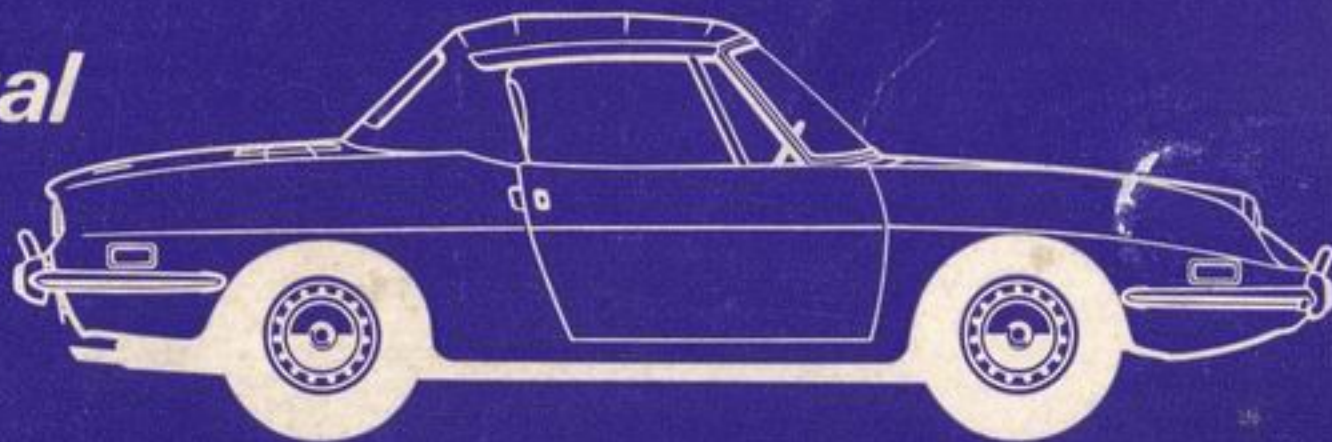

## **OWNERS WARRANTY AND SERVICE BOOK**

All the service operations under the FIAT warranty are listed in this book issued with every new car.

The Book includes two Service Coupons covering the free checks, adjustments and lubrication (cost of lubricants excepted) to be performed by FIAT Dealers on completion of the first 1000-1300 miles and 2500-3500 miles of driving.

It is your own interest to report for Free Service at the specified mileage intervals to obtain best performance and preserve the efficiency of your car.

## **SPARE PARTS**

Use exclusively genuine FIAT spares. It is the best guarantee for top performance and satisfactory operation of all components.

When ordering, please quote (see page 3):

- Car model.
- Chassis type and number.
- Engine type and number.
- Number for Spares.
- Part number(s) of spare(s) ordered.

## **When you want to know**

	<i>page</i>
<i>How to change a wheel . . . . .</i>	19
<i>The correct tire pressures . . . . .</i>	45
<i>How to change a lamp bulb . . . . .</i>	37
<i>How to replace a blown fuse . . . . .</i>	39
<i>How to use the heating and ventilation system . . . . .</i>	15
<i>The refill capacities . . . . .</i>	45
<i>How and when to lubricate . . . . .</i>	23
<i>How to adjust carburetor . . . . .</i>	28
<i>and, for any other question, consult the Contents list on page</i>	2

*This Manual illustrates  
and describes  
the operation and maintenance  
rules which will consistently  
ensure the safe and satisfactory  
performance of your car,  
if followed properly.*

*In the accompanying booklet  
« Safe Motoring Hints »,  
also supplied with every car,  
you will find those suggestions  
on driving know-how  
which it always pays to remember.*

*Both publications  
aim at helping you cover safely  
thousands of troublefree miles.*

- **operation**
- **maintenance**
- **specifications**



**North American Version**

# CONTENTS

	Page
Keys . . . . .	3
Identification data . . . . .	3

## OPERATION

Break-in recommendations . . . . .	5
Instruments and controls . . . . .	7
Starting the engine . . . . .	12
On the road . . . . .	12
Parking . . . . .	12
Doors . . . . .	13
Seats . . . . .	13
Safety belts . . . . .	14
Ventilation and heating . . . . .	15
Fold-away top . . . . .	16
Hard top . . . . .	18
How to change wheels . . . . .	19
Jacking up and towing . . . . .	20

## MAINTENANCE

General lubrication chart . . . . .	23
Cleaning, inspection and adjustment chart . . . . .	25
Engine lubrication . . . . .	26
Valve gear	
Valve tappet clearance . . . . .	26
Valve timing . . . . .	27

<b>Fuel system</b>	Page
Air cleaner . . . . .	27
Carburetor . . . . .	28
Crankcase emission control system . . . . .	28
Exhaust emission control system . . . . .	28
Fuel evaporative emission control system . . . . .	29

<b>Engine cooling system</b>	
Permanent coolant circuit . . . . .	30
Drive belt tension . . . . .	31

<b>Ignition system</b>	
Ignition distributor . . . . .	31
Spark plugs . . . . .	32
Ignition timing . . . . .	32

<b>Power train</b>	
Clutch pedal free travel . . . . .	32
Transmission and axle oil . . . . .	32

<b>Brakes</b> . . . . .	33
-------------------------	----

<b>Suspension</b> . . . . .	34
-----------------------------	----

<b>Steering and wheels</b>	
Wheel alignment . . . . .	35

<b>Generating and starting equipment</b>	Page
Battery . . . . .	36

<b>Headlights and various lamps</b> . . . . .	36
---	----

<b>Wiring diagram</b> . . . . .	38
---------------------------------	----

<b>Fuses</b> . . . . .	39
------------------------	----

<b>Miscellanea</b> . . . . .	40
------------------------------	----

## SPECIFICATIONS

Engine . . . . .	41
Power train . . . . .	42
Brakes . . . . .	42
Suspension . . . . .	42
Steering and wheels . . . . .	42
Electric system . . . . .	43
Main dimensions . . . . .	44
Performance . . . . .	44
Weights . . . . .	44

<b>Fill-up data</b> . . . . .	45
-------------------------------	----

## IMPORTANT

The American system measures are given merely for Customer's convenience and, though the closest possible approximation is sought, they are sometimes rounded off for practical reasons. **It must therefore be understood that in case of any discrepancy the metric units are the only valid reference.**

# KEYS

Each vehicle is provided with two keys in duplicate:

**A** - for ignition lock switch

**B** - for the doors and drop tray.

Quoting the number on key bow will be sufficient to obtain a replacement key from FIAT's Sales Organization. Therefore, our suggestion is to record this number upon delivery of the car.

**Note.** - If it proves difficult to insert key in lock, try to rub a lead pencil point on biting and in grooves. Normally, this should solve the problem.



# IDENTIFICATION DATA

## ■ Identification Plate.

- a** - Chassis Type (**100 GBS1**).
- b** - Chassis Number.
- c** - Order Number for Spares (preceded by letter **A** which identifies the **North American version** cars and must always be quoted in the orders for spares).
- d** - Body Paint Color Number.
- e** - Engine Type (**100 GBS.040**).
- f** - Top Paint Color Number.

## ■ U.S. Safety Standard 115 tag:

Type of vehicle and chassis number, located on fascia top between instrument cluster and windshield.

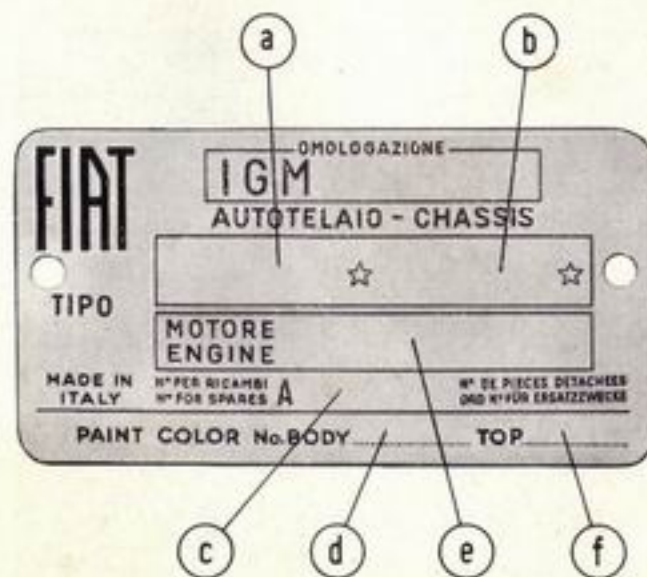

- **U.S. Safety Standard conformity tag:** Year and month of manufacture, chassis number and car type, applied on left side door pillar, below lock striker.



- **U.S. Safety Standard 110 tag:** Tire data and vehicle capacity, located on right door pillar, above the lock striker plate.



- **Air Pollution tag:** Main data for correct engine adjustment according to which the car meets the regulations, located in engine compartment, to the right, above radiator.

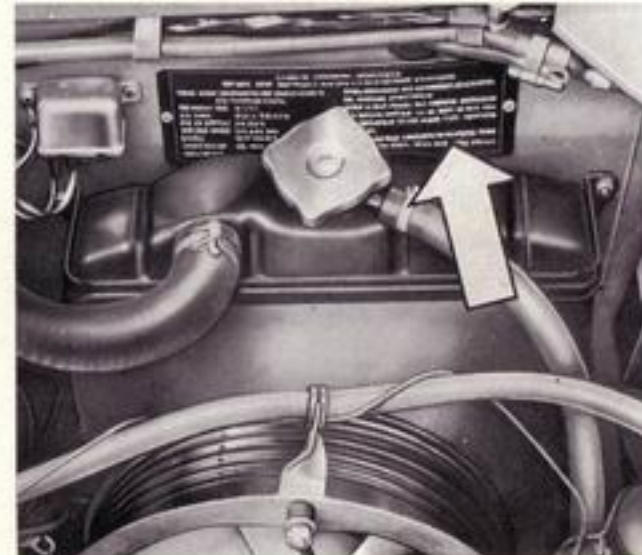

# OPERATION

## **BREAK-IN RECOMMENDATIONS**

Current progress in design and manufacturing technology is so advanced that you may drive your new car without the need of observing stringent rules during the first period of operation. However, a few simple rules should be followed for the first 1000 miles:

- Avoid brief full-throttle accelerations during engine warm-up after starting (a good habit even after break-in).
- Do not press in fully the accelerator pedal and exercise the necessary care when operating in the lower gears to avoid high engine speeds, that is, never allow the

tachometer pointer to move into the yellow area indicating high rpm rates.

- Change your road speed occasionally, especially on long trips. Hence, avoid long drives at constant speed, be it high or low.
- Downshift whenever necessary to cope with driving conditions on route: you will avoid engine laboring at excessively low rpm.
- Avoid, if possible, severe stops at sustained speeds during the first few hundred miles: brakes will

« set » properly and improve their life and effectiveness.

- Do not change the oil contained in your new engine before having travelled the first 1000-1300 miles - Operation covered by Coupon **A** of the Warranty Book.

Remember that the satisfactory operation and long life of engine, and of mechanical units as well, are dependent to a great extent on the moderation with which the car is used during the first few thousand miles.

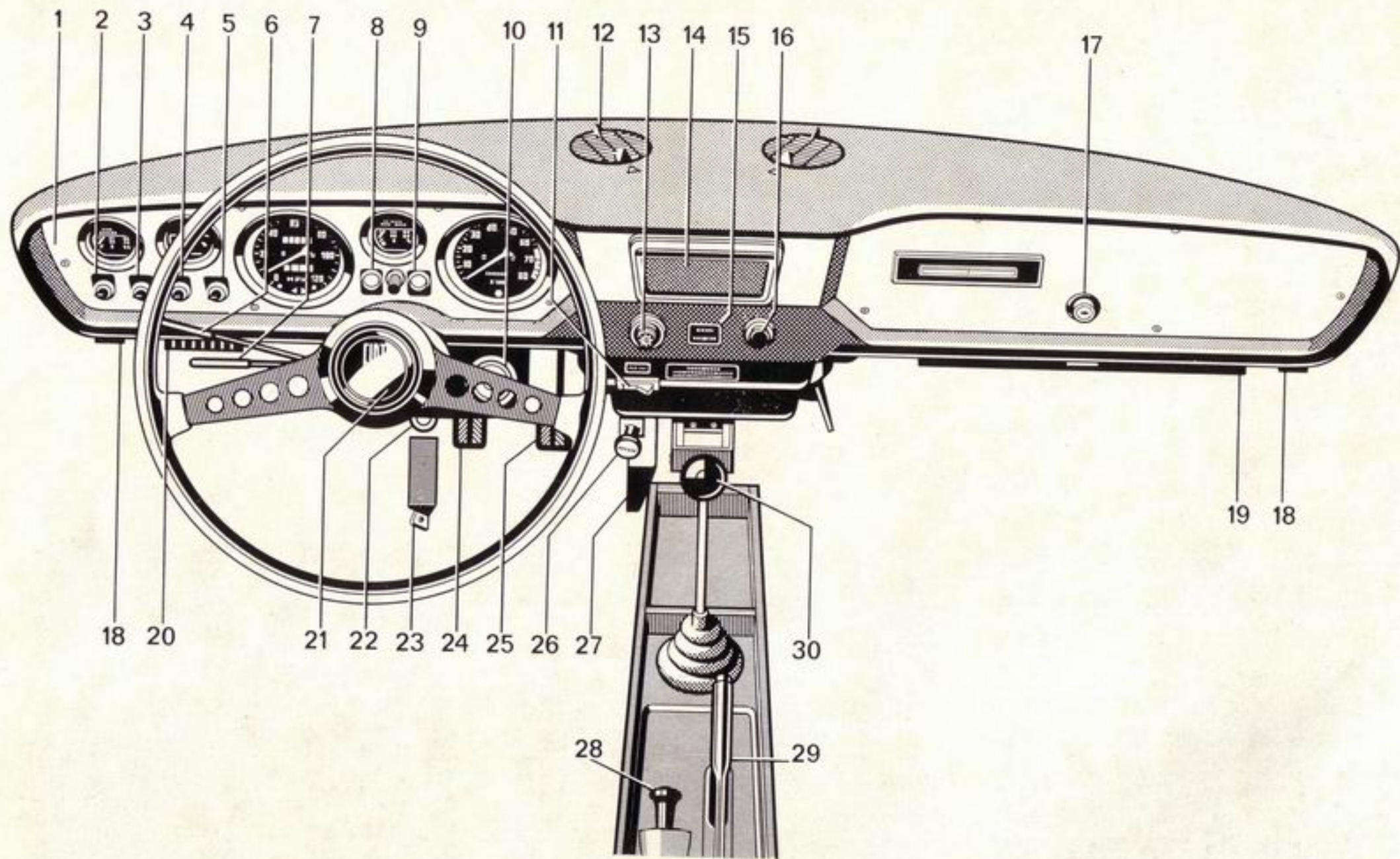



# ***INSTRUMENTS AND CONTROLS***

- 1.** Instrument cluster.
- 2.** Vehicular hazard warning signal switch.
- 3.** Two-speed windshield wiper switch.
- 4.** Courtesy lights switch.
- 5.** Outer lighting switch.
- 6.** High/Low beams change-over switch lever.
- 7.** Turn signal lights control lever.
- 8.** Vehicular hazard warning signal pilot light.
- 9.** Brake system effectiveness indicator.
- 10.** Lock switch with anti-theft device.
- 11.** Two-speed electrofan switch: see page 15 for operation.
- 12.** Adjustable outlets, ventilation and heating: see page 15 for their use.
- 13.** Light intensity adjustment rotary knobs for instrument lights and parking light indicator.
- 14.** Ash tray.
- 15.** Fasten belts indicator.
- 16.** Cigarette lighter: press-in to operate.
- 17.** Drop tray lid button.
- 18.** Courtesy lights under dash.
- 19.** Drop tray.
- 20.** Fuses.
- 21.** Horn button.
- 22.** Windshield washer and wiper foot control.
- 23.** Foot rest.
- 24.** Clutch pedal.
- 25.** Service brake pedal.
- 26.** Throttle knob.
- 27.** Accelerator pedal.
- 28.** Choke knob.
- 29.** Hand brake lever.
- 30.** Gearshift lever.

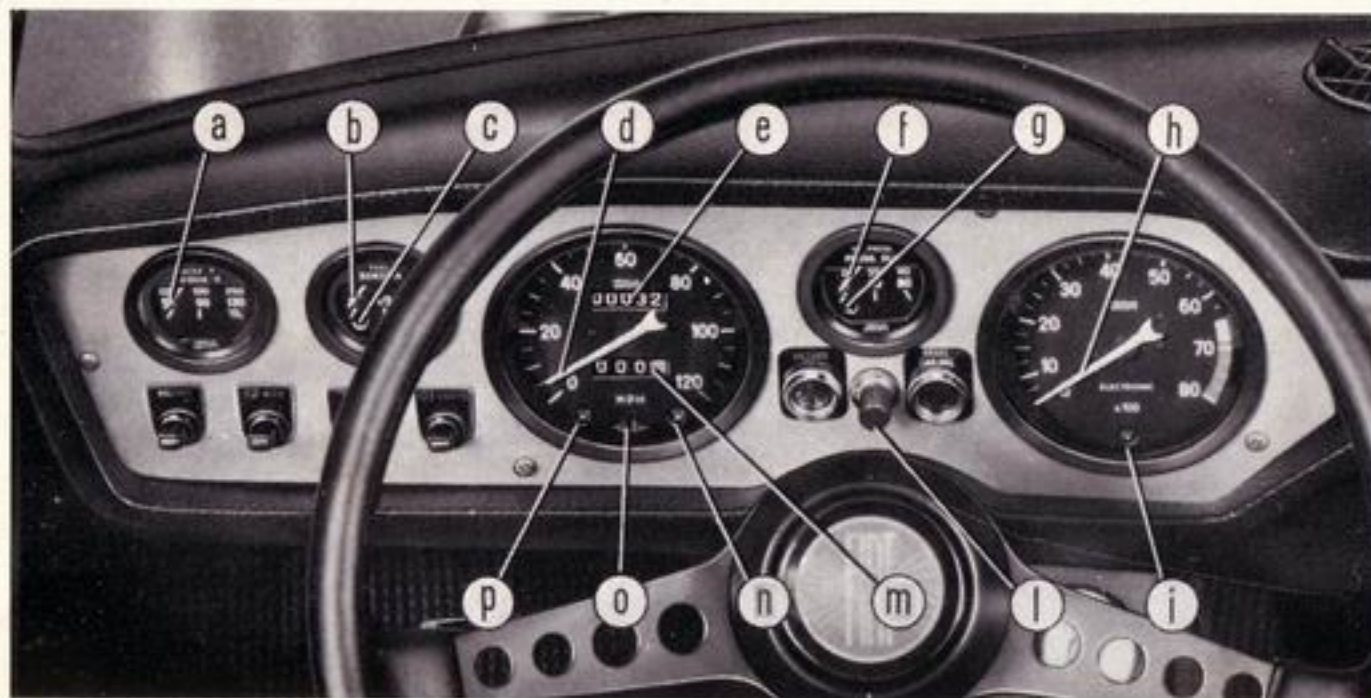

**Instrument cluster, incorporating :**

**a) Engine Water Temperature Gage:** The light sector of dial (white line) indicates that engine operation temperature is regular. When the pointer enters the red sector it is a warning of engine overheating: should this occur, it will be necessary to immediately rev down the engine to idle speed (do not switch off). If the pointer remains on the red area, have the

cooling system checked by the nearest FIAT Dealer.

**b) Fuel Gage.**

**c) Fuel Reserve Indicator (red):** Lights up when only 4 to 5.5 liters (1-1½ Gals) of fuel remain in tank.

**d) Speedometer.**

**e) Odometer (totalizer).**

**f) Oil Pressure Gage:** Rated lubrication pressure is 3-4 kg/cm<sup>2</sup> (42 to 57 psi).

**g) Insufficient Oil Pressure Indicator (red):** Lights up when oil pressure is inadequate for good engine lubrication. When engine is hot and rpm low, the indicator may turn ON even if everything is normal.

**h) Engine Tachometer:** Electronically operated by ignition distributor. The dial yellow sector indicates high engine rpm rates in all gears. The red sector indicates dangerous R.P.M. rates.

**i) Battery Charge Indicator (red):** With engine inoperative, and lock switch key on **MAR**, see page 10, the indicator is on and must go out when engine is started; should the indicator stay or turn on while engine is running, this warns of a fault in the battery recharging system: turn immediately to a FIAT Dealer for assistance.

**l) Trip Recorder Zeroing Knob:** Turn **clockwise** to zero the recorder, but **never** with vehicle running.

**m) Trip Recorder.**

**n) High Beam Indicator (blue):** Turns on when headlight high beams are ON.

**o) Turn Signal Arrow Indicator (green):** Flashes when the turn signal switch lever is moved down or up.

**p) Parking and Tail Lights Indicator (green):** Lights up when outer lighting switch is ON.

**Outer Lighting Three-position Switch:**

*Up* = All lights OFF.

*With Ignition Key in:*  
*Down* = parking and tail lights, headlight low or high beams and flashes (main beams); cluster lights and cigarette lighter housing indicator.

*With Ignition Key Removed:*  
*Center* = (night parking only) = parking and tail lights, cluster lights, cigarette lighter housing indicator.  
*Down* = All lights OFF.

**Fasten Belts Indicator (red) and Buzzer:** Both are operative when key is inserted in lock switch and transmission is shifted into gear: the indicator and buzzer will go out only when the driver and front passenger, if any, have worn the seat belts.

**Brake System Effectiveness Indicator (red):** Lights up if pressure in either brake hydraulic circuit (front or rear) is excessively low due to leakages or line failure.

A switch on the hand brake lever allows the driver to make sure that the bulb is operable and at the same time turns on the indicator if the lever is pulled upwards (brake applied).

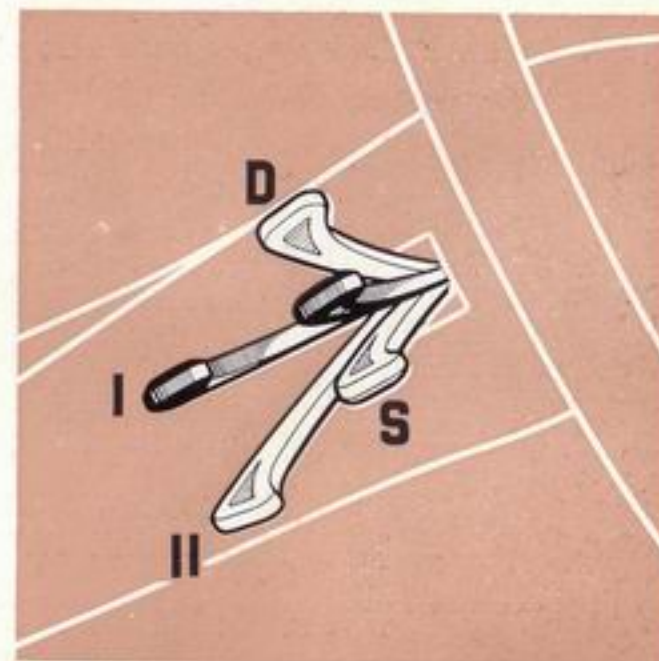

**High / Low Beams Change - Over Switch Lever** (with outer lighting switch down and key in lock switch):

**I** = Low beams

**II** = High beams

By tripping the lever towards steering wheel headlight high beam flashes are obtained even with all lights out (Daylight signals).

**Turn Signal Lights Control Lever:** Automatically trips back to OFF.

**D** = Right turn.    **S** = Left turn.

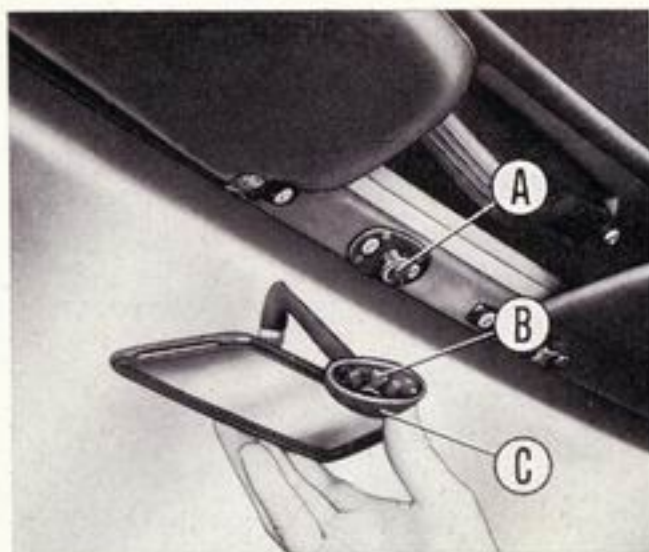

**Collapsible Inner Rear View Mirror:** If the mirror comes off its seat, following an impact, refit by engaging spring **B** on stud **A** — make sure the two location dowels are properly registered with relevant seats — and pressing on base **C**: engagement is of the snap-on type.

Swivelling rear view mirror on the outside of steering wheel side door adjustable from driver's seat.



**Lock Switch:** controls ignition, accessories, starting and the steering post anti-theft lock device (\*).

**Remove Key Buzzer:** Operates when the steering wheel side door is opened to leave the car and the ignition key is forgotten in lock switch.

**MAR** (*Run*): Engine ignition ON and accessories energized.

**AVV** (*Start*): Engine starting.

**ST** (*Stop*): Steering post lock anti-theft device in; permits key removal.

Steering post remains locked only after key is removed.

To facilitate the disengagement of steering post lock, rock slightly the steering wheel while rotating the key.

Key **must not** be left in position **MAR** when engine is inoperative and must be removed when leaving the car unattended.

(\*) Even with key removed (position **ST**) the following circuits are always energized: courtesy lights; horns; cigarette lighter and housing indicator; vehicular hazard warning signal; and remove key buzzer.

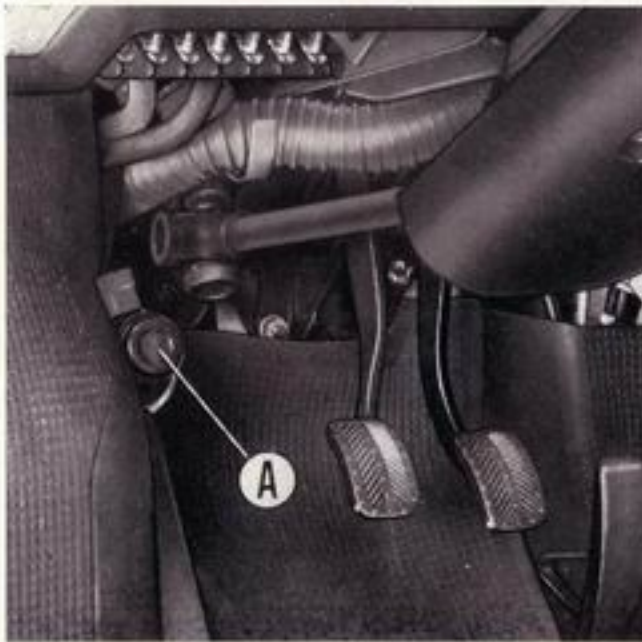

**Windshield Washer and Wiper Foot Control A:** To clean windshield depress several times this control which turns on first the wiper and then the washer.

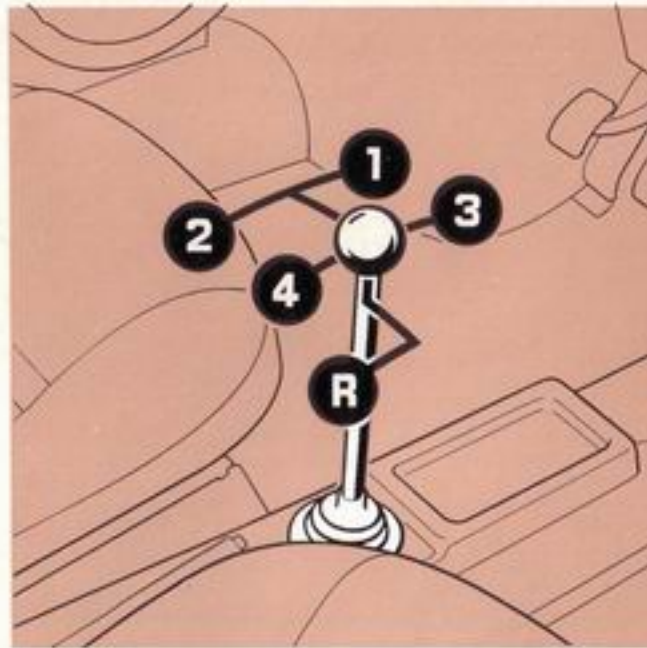

### Gearshifting Pattern

To engage reverse (R), **press in** the lever and shift as shown.

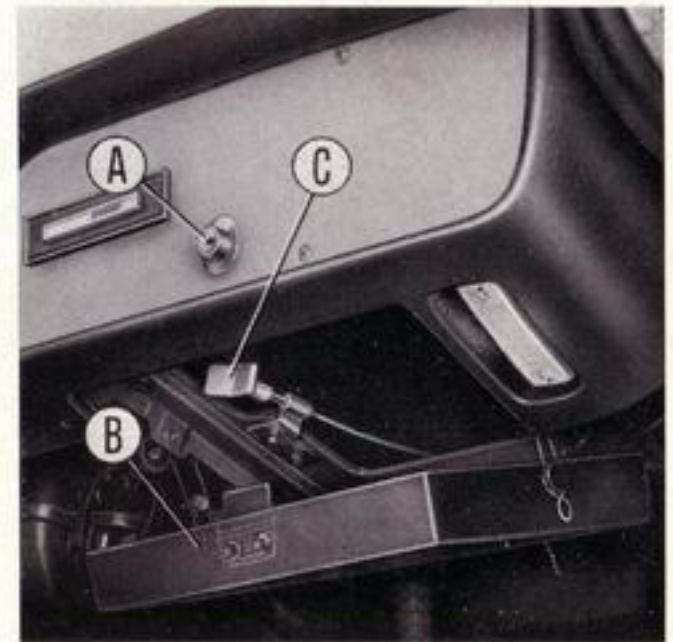

**To open drop tray B,** press release button **A**, after unlocking it with the door key, then pull the tray down.

Front compartment lid latch is released by **pulling** control handle **C** located in tray housing. The lid is kept in the open position by a spring-loaded prop.

To lock the front compartment lid **push in** handle **C**.

## **STARTING THE ENGINE**

### **Cold Starts**

Set the controls as follows:

- Gearshift lever in neutral.
- Choke knob **28** (page 6) pulled fully out.
- Insert and turn lock switch key clockwise to the stop, i.e., position **AVV**, page 10, and keep it there until engine is started up. Then, release hold: the key will snap back to position **MAR**.
- Once engine has started, push choke knob home **gradually** to ensure a smooth running of engine during warm up.

**Do not press accelerator pedal** until engine is well started.

**Avoid sudden accelerations when engine is cold.**

### **Hot Starts**

When engine is warm, start without disturbing the choke knob.

In case engine is **very hot**, it may be necessary to **fully depress** accelerator pedal which shall be released slowly as soon as engine fires.

**Do not pump the accelerator**, as each pedal stroke actuates the accelerating pump which, by providing an excessively rich mixture, would make engine starting difficult.

## **ON THE ROAD**

- **Never keep on driving (even downhill)** when tachometer pointer dwells on dial red sector.
- When pointer is on the dial yellow sector adapt your driving con-

duct to high speed motoring requirements.

- During regular engine operation, **all warning signals (red indicators)** in instrument cluster **must be OFF**. If any of these indicators lights up, investigate and remedy accordingly.
- Occasionally, check that everything is under control by glancing at gages and indicators on panel.

## **PARKING**

When the car must be left unattended on a slope apply the hand brake and **engage exclusively the 1st gear** regardless of the car being headed uphill or downhill.

At night, in dark areas, turn ON also the parking lights.

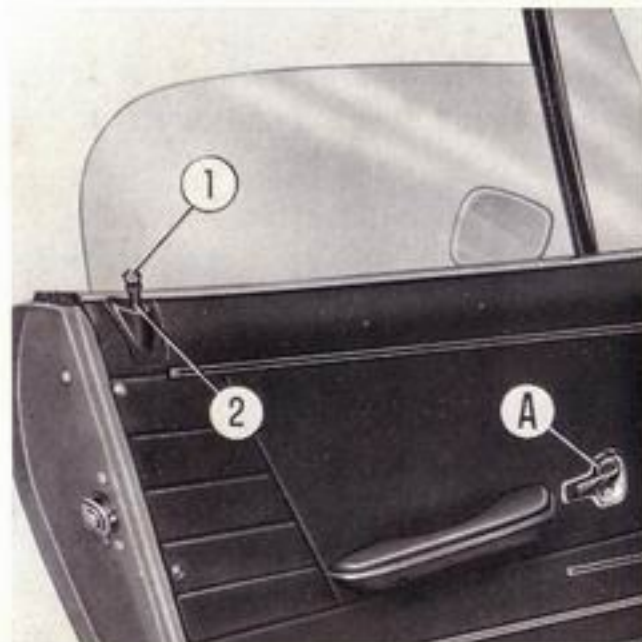

## DOORS

Both doors are provided with key-controlled button release lock.

**Stepping out and locking the car on the curb side is thus also possible.**

To open doors from inside just pull lever **A**.

Doors may be locked from inside **only if already shut**: to lock, move the latch knob from position **1** (free) to position **2** (locked).

**Never depress the knob when the door is open as not only will the**



**door remain unlatched but the lock itself might suffer damages.**

From outside, doors can be locked **only with the key**. This prevents forgetting the keys in the locked car. When one of the doors is opened, the courtesy lights under dash are automatically turned on.

**Note.** - Lubrication of lock cylinders is not recommended; at most, blow some graphite powder into the cylinder keyhole. In winter it is recommended to squirt some special antifreeze fluid for locks: then repeat the operation every time the car is washed or at least every 15 days. If in extremely cold weather, insertion of



key in the frozen lock cylinder proves difficult, just warm up the key.

## SEATS

The position of seats on floor is adjustable longitudinally after moving the control lever upwards.

Seat squabs can be tilted forward to facilitate access to rear recess serving as luggage space (when fabric top is up or when the hard top is fitted).

Seat squabs with locking device and integral headrest. To tilt the squab press in the button and push.

## SAFETY BELTS

Safety belts are provided as standard original equipment and are of the 2-point type (lap).

Free belt connector **A** from its storage retainer **C**.

Pull belt from retractor without stopping; if pulling motion is interrupted during extension of the belt, it will be necessary to return the belt completely to the stowed position to release the stop mechanism.

To fasten, insert connector **A** into buckle slot **B** until a snap is heard.

Adjust belt snugly around the hips-not the waist - by allowing excess belt to return into retractor.

The indicator light and buzzer will go out only when, after extending the front belts, the retractors begin recovery of excess length.

To release the belts: simply press in the center button to release the buckle.

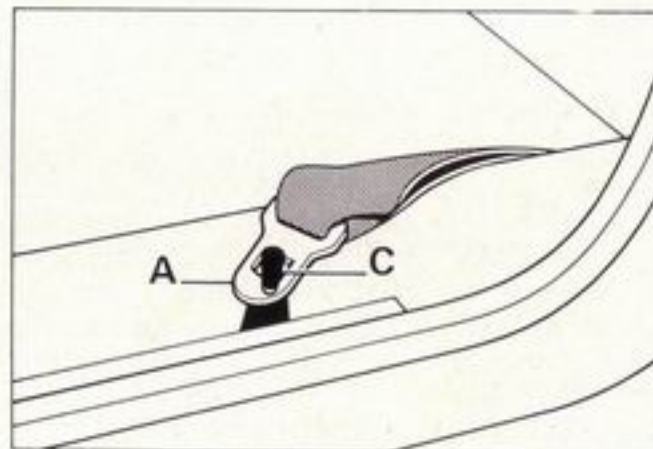
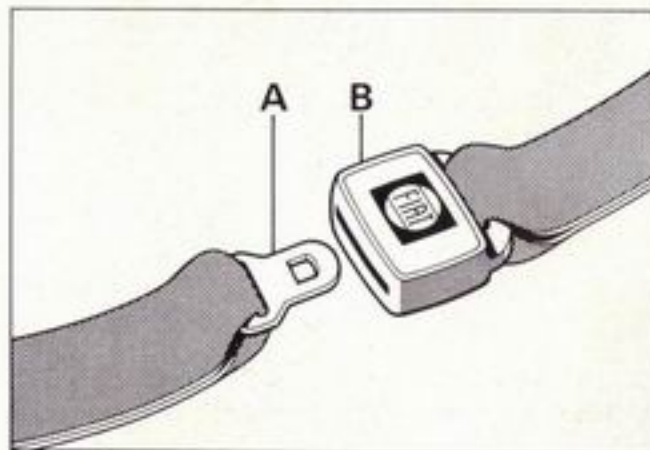

**Warning.** - The adjustment of seat belts must be made before starting the car and after having properly positioned the rear view mirrors.

Each belt is intended for use by one adult or one child over 6 years of age. Belt adjustments must be made with occupant sitting well back and erect in the seat. Make sure webbings are not twisted.

Occasionally, check that mounting bolts are tight, and that webbing is not cut or frayed.

In the event of an accident, even if the belt you were wearing is apparently undamaged it is recommended that you replace it with a new belt. To keep belts clean, hand wash only, using warm water and mild soap. Rinse and dry thoroughly - out of direct sunlight. Do not use strong detergents. Do not use bleaches or dyes.

Avoid any chemical that may weaken the equipment.

Users are warned to consult the manufacturers in case of doubt and not to make any alterations of, or additions to, seat belt assemblies and/or anchorages.



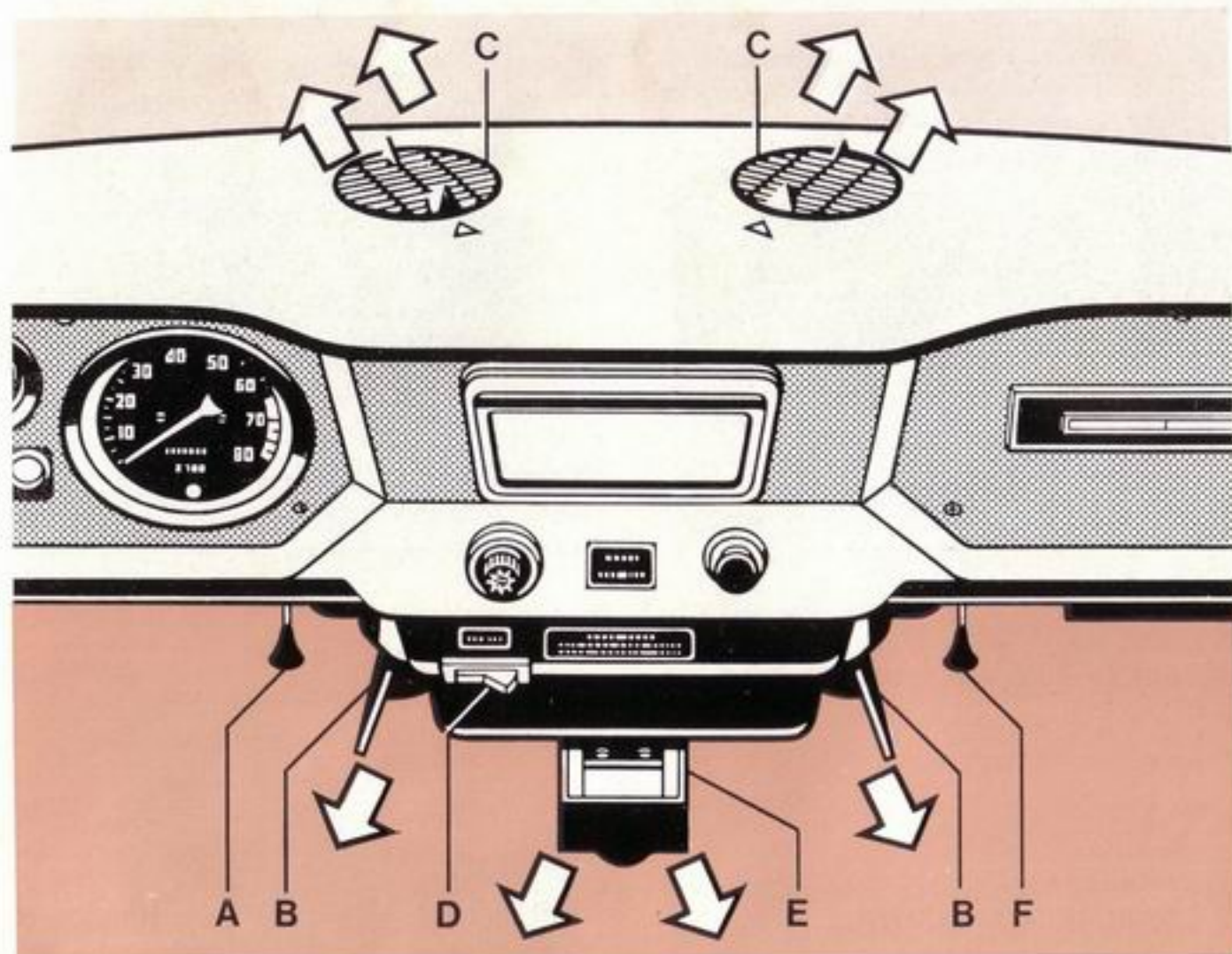

## VENTILATION AND HEATING

### Admission of Heated or Fresh Air

The 3-position fan switch **D** is energized only when lock switch key is

in positions « **MAR** » or « **ST** ».

*Pressed in at right* = High speed.

*Intermediate position* = Off.

*Pressed in at left* = Low speed.

The fan is switched on to increase flow of air at low car speeds.

Lever **F** sets the temperature of the heated air flowing through directional outlets **C** and shutters **B** and **E**.

*Moved completely down*: maximum temperature of heated air.

Lever **A** sets the amount of fresh air flowing through directional outlets **C** and shutters **B** and **E**.

*Moved completely down*: maximum flow of fresh air.

The air temperature and flow may be adjusted at will, by suitably setting the relative position of the two control levers **F** and **A**.

### Demisting and Defrosting

To demist or defrost windshield, send air against the glass through outlets **C**; this may also be heated air (essential in winter) and its amount is increased by partially or totally closing the shutters.

**Note.** - Should heating be insufficient, have the operation of thermostat in cylinder jackets-to-radiator duct checked.

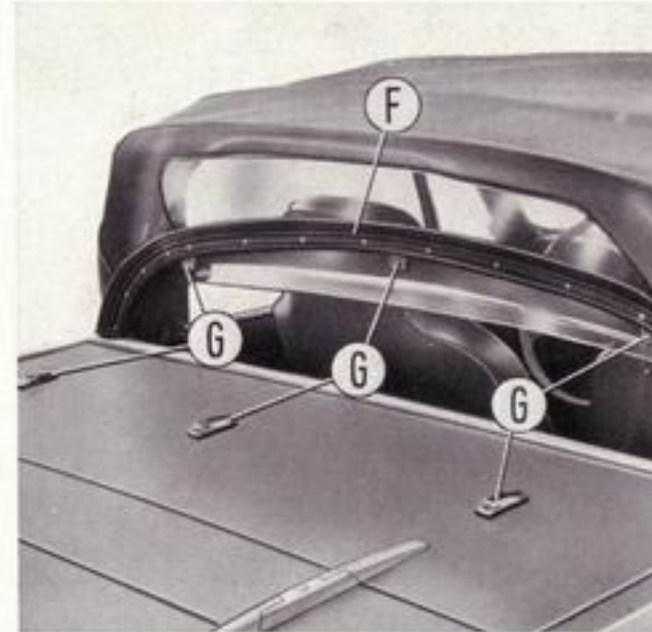
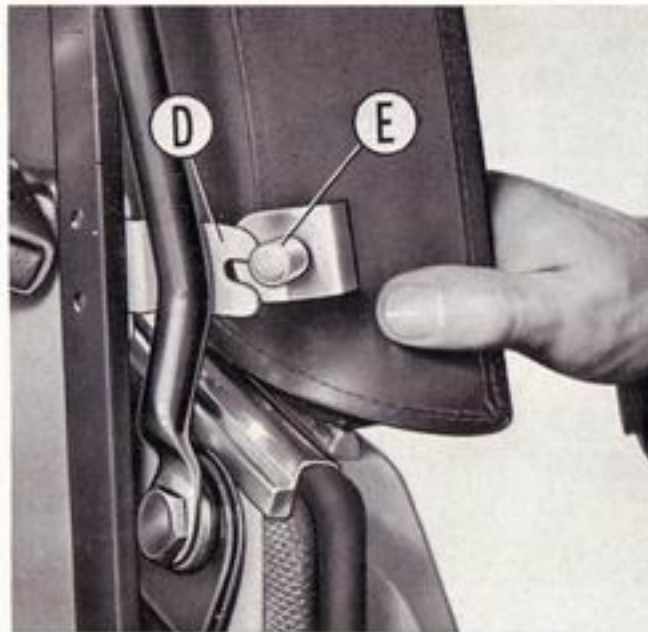
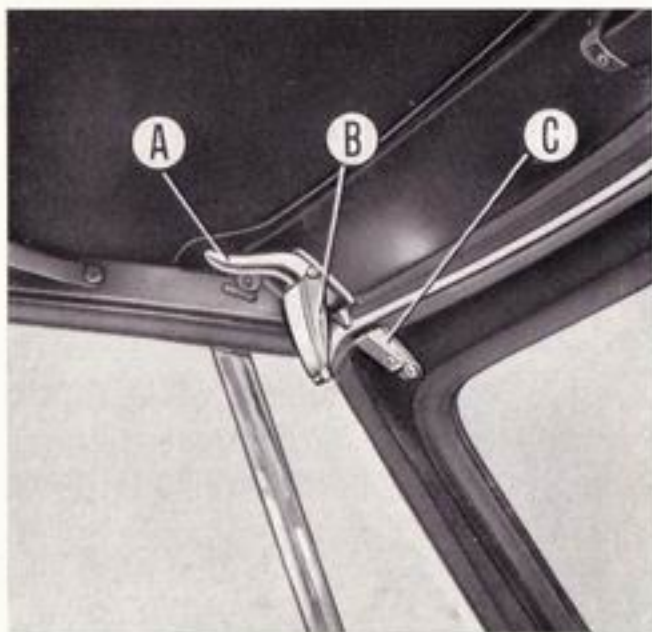

## **FOLD-AWAY TOP**

To fold down the top, proceed as follows:

1. Lower the two catch levers **A** and release clamps **B** from catches **C** securing the top to windshield frame.
2. Lower door windows.
3. Disconnect side flap lock pin **E** from seat in lock plate **D**.
4. Pull backward rear cross rail **F** to free it from the three hooks **G**.
5. While keeping cross rail **F** lifted (avoid excessive folding of flexible back window) turn handle **H** to unlock lid **I** and raise the lid until it locks and is held in open position by spring strut **L**.
6. With side flaps (and lock pins **E**) outside and rear cross rail held against the last bow, fold the top.

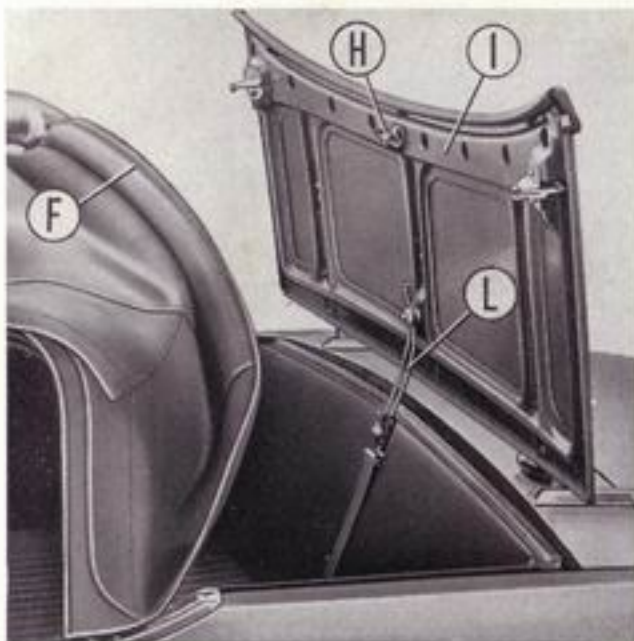

7. Before lowering the top completely down, make sure that the material is not pinched in the frame (pull the material carefully on both ends towards car back), and that lock pins **E** do not interfere with top arms (hold flap pins close against body).

8. Fold forward the fabric free end taking care that the two clamps **B** are tilted down and back.

9. Secure folded top by the rubber strap (make sure back window is not crimped) and lock lid **I**. Locking of lid may be facilitated by pressing down with the palm of the hand over the area of the two latches **M**.

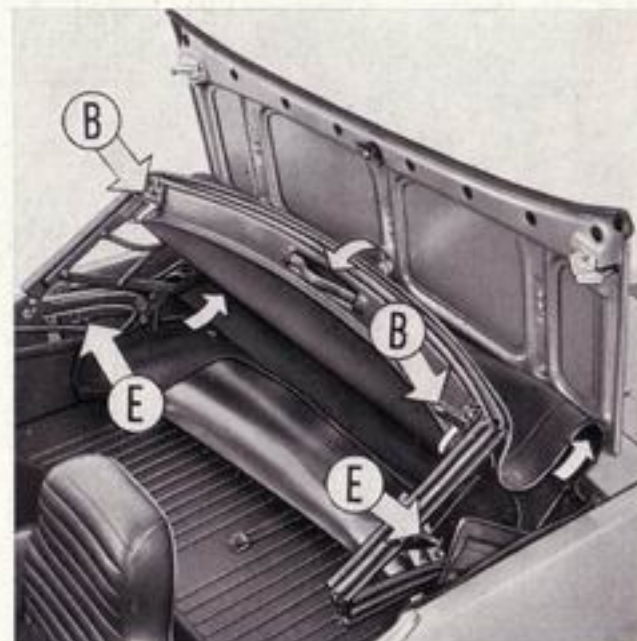

**Warning.** - Do not fold the top when wet to prevent staining which will be difficult to remove. The top may be cleaned using a PVC foam cleaner or sudsy water.

Occasionally sprinkle with talcum powder the cross rail rubber strip on body to avoid possible deterioration of paint finish by prolonged pressure.



## HARD TOP

### Removal

Proceed as follows:

1. Remove the four screws **A** (two on either side) securing the top to windshield.
2. Remove the two screws **B** (one on either side) near door locks, after taking off their caps.
3. Raise the complete top and unscrew the four nuts **C** (two on either side) securing the top to outer hinges (these hinges serve also for the folding top lid).

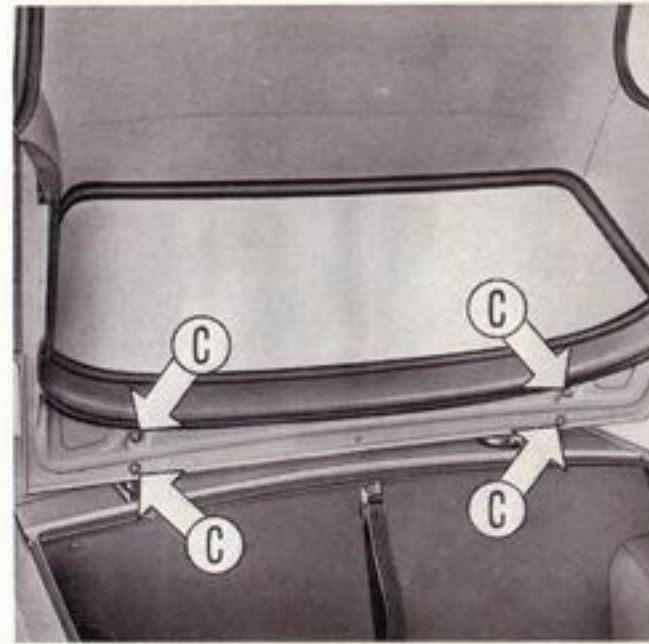
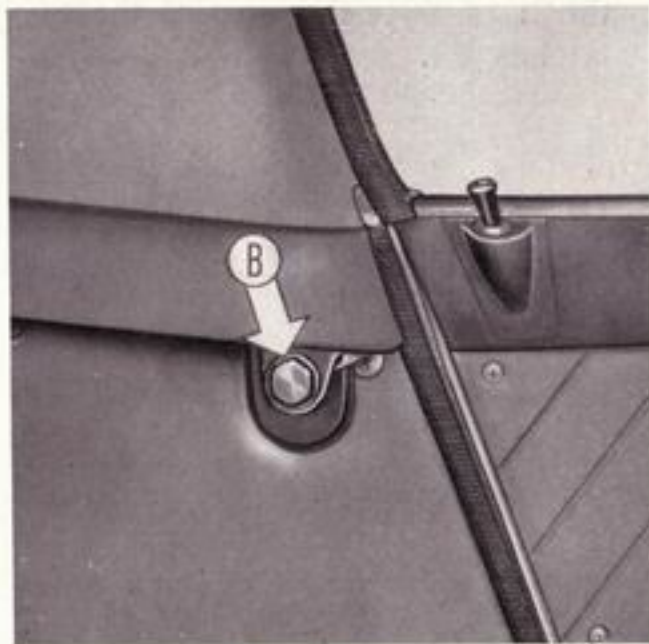

## HOW TO CHANGE WHEELS

To change a wheel proceed as follows:

- a) Place the car possibly on level ground and lock rear wheels by the hand brake.
- b) Remove the wheel cap and using the speed handle slacken about one turn the four wheel fixing screws.
- c) Place jack nub in bracket under body floor, lift until the wheel to be removed clears the ground.
- d) Remove the four fixing screws. Pull off wheel. Place the screws inside the upturned wheel cap: this will prevent the threads from getting fouled with dirt, a frequent cause of difficulties at reassembly.

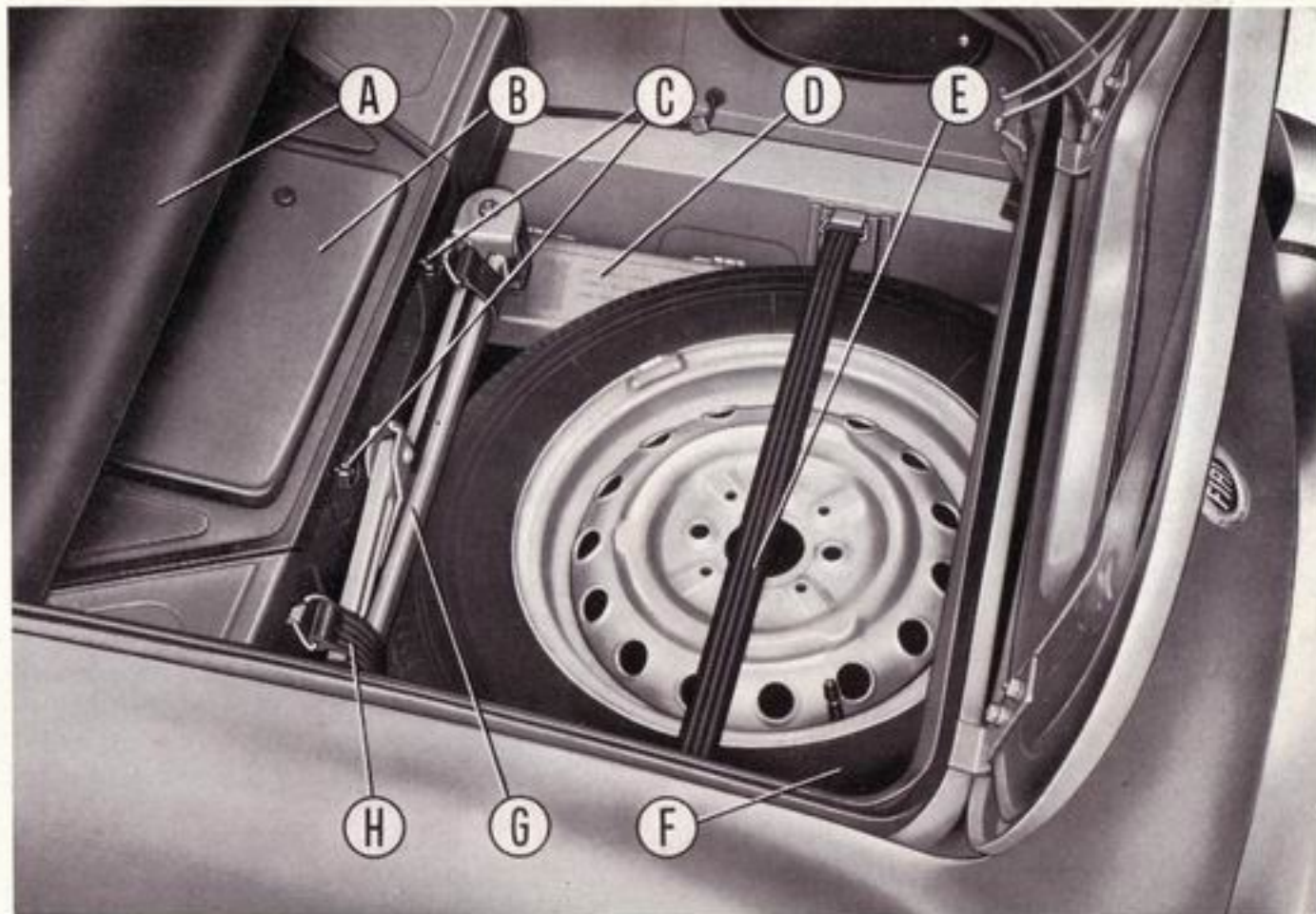

**A.** Mat, rolled up. - **B.** Battery well cover. - **C.** Cover B locking knobs. - **D.** Tool box. - **E.** Spare wheel fastening strap. - **F.** Spare wheel. - **G.** Jack. - **H.** Jack fastening straps (two).

e) Mount the spare wheel. The wheel location dowel must fit into one

of the four location holes provided in wheel disc.



- f) Insert the fixing screws and tighten uniformly in criss-cross sequence.
- g) Lower car and disinsert jack nub from bracket under floor.
- h) Fully tighten the wheel fixing screws and refit the wheel cap.
- i) Check if the pressure of the newly mounted wheel is as specified.

Before stowing away the jack fold back its nub and turn the crank until the nub end locks on jack base. This will prevent rattling noises during subsequent car operation.



### ***JACKING UP AND TOWING***

When either the front or rear end of car must be raised with a garage jack, it is indispensable to fit jack head under the special brackets, as shown.

If car needs towing, the rope must be attached exclusively to the front central jack bracket.

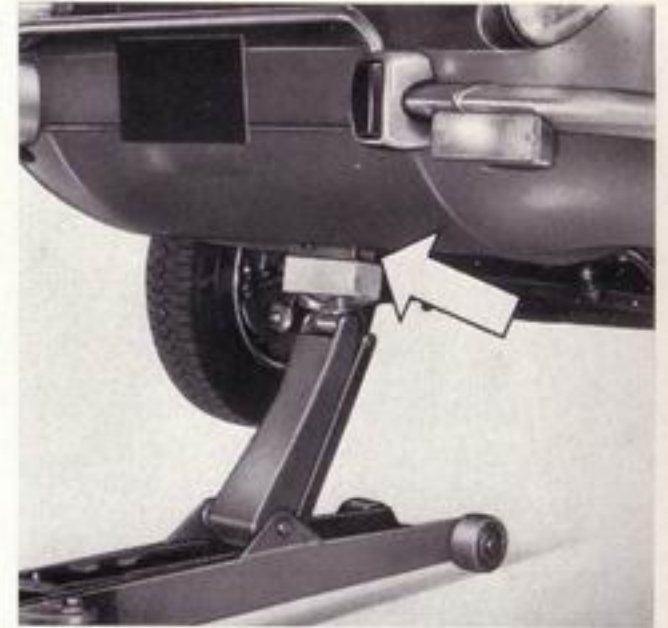

# MAINTENANCE

## SERVICE DEALERS

Not all the specified maintenance operations can be carried out easily by the Owner who usually does not have proper equipment at his disposal.

Therefore, the car should be taken to one of the many FIAT Service Dealers whenever assistance is needed.

At these authorized FIAT Service Centers, any overhaul and repair work is carried out by skilled personnel using specially designed equipment.

FIAT's Organization is at your disposal. Do not hesitate to write for any explanation or suggestion that will ensure top car performance and best efficiency.

When your car needs Service look for this sign.



## CONSULTING THE CHARTS

The periodical maintenance operations recommended in relation to given mileages, are listed in two charts: one covers the points to be lubricated and the other the cleaning, inspection and adjustment operations.

Each operation is identified by a number and, in the corresponding note, reference is made to the page where the operation is described.

In addition, each lube point on the Lubrication Chart is marked with a symbol indicating the grade of lubricant to be used. For oil grades not mentioned here, see the « Fill-up Data » Table.

Particular stress is laid on the importance of reporting to a FIAT Dealer for all the maintenance operations marked



## NOTICE



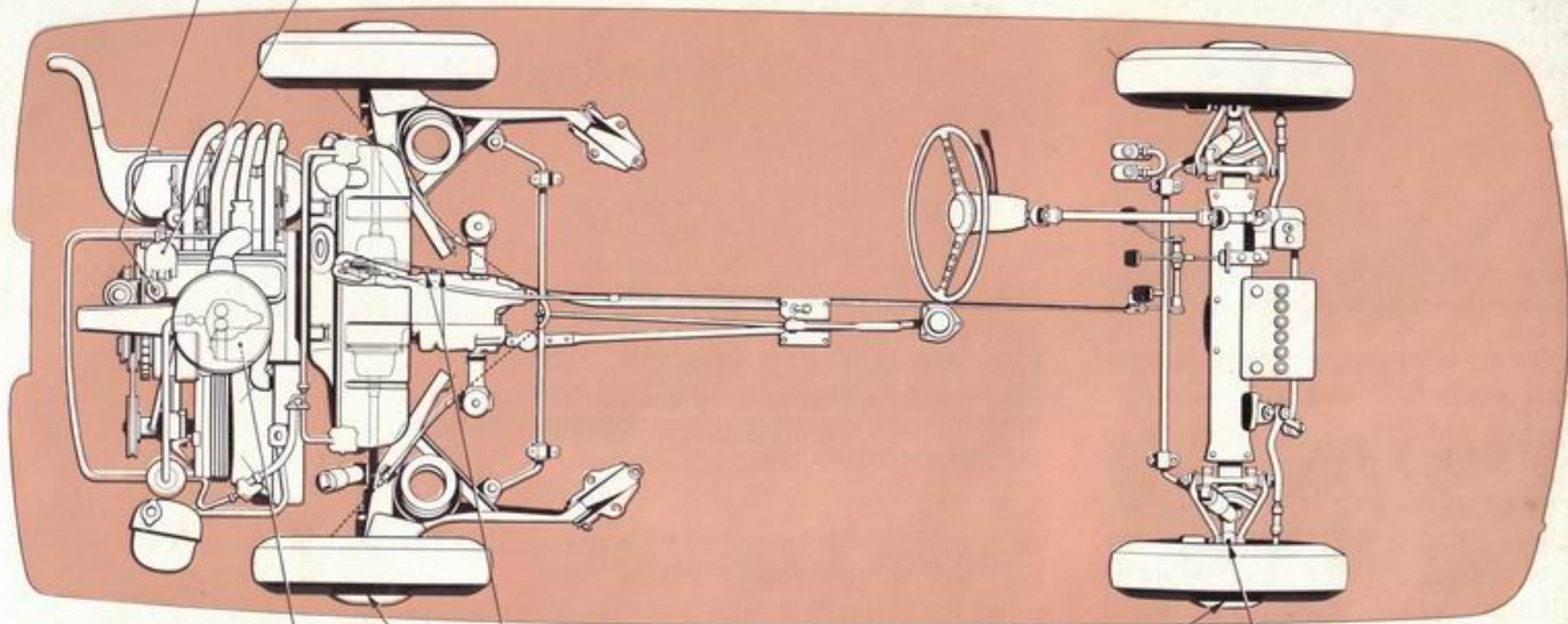

Besides the routine maintenance operations listed in the charts, this chapter describes other operations which must be performed only in special cases of defective operation of mechanical units.

All the operations marked thus ■ in the two lists **must be entrusted** to the **FIAT Service Network**.

10.000 km — 3 — 4 —  
 500 km — 1 —



10.000 km — 5 —  
 30.000 km — 8 — 7 — 6 —  
 5.000 km — 2 —  
 7 —

-   
**FIAT engine oil**
-   
**FIAT W 90/M oil**
-   
**FIAT Jota 1 grease**
-   
**FIAT MR 2 grease**
-   
**FIAT MR 3 grease**



## GENERAL LUBRICATION CHART

### Every 500 km (300 miles) or weekly

	See page
1. Engine oil: <i>Check level and top up as required</i> . . . . .	26

### Every 5,000 km (3,000 miles)

2. Kingpins: <i>Inject grease in lubricator</i> . . . . .	34
---	----

### Every 10,000 km (6,000 miles)

3. Engine oil: <i>Change oil with warm engine</i> . . . . .	26
4. Ignition distributor: <i>Lubricate through wick</i> . . . . .	31
5. Transmission and axle oil: <i>Check level and top up as required</i> .	32
– Body: <i>Lubricate the various items</i> . . . . .	40

### Every 30,000 km (18,000 miles)

6. Transmission and axle oil: <i>Change oil</i> . . . . .	32
7. Front and rear wheel bearings: <i>Lubricate</i> . . . . .	35
8. Starter: <i>Lubricate</i> . . . . .	36

### Lubricant Designations

FIAT	INTERNATIONAL
« VS »	<b>Low-ash content detergent oil</b> - API Service SD, CC - meeting the European Sequence
« Multigrado »	
« W 90/M »	<b>SAE 90 EP</b> oil meets MIL-L-2105 B requirements
« Jota 1 »	<b>Lithium-base</b> grease N.L.G.I. No. 1
« MRM 2 »	<b>Lithium-base</b> grease, with molybdenum disulphide N.L.G.I. No. 2
« MR 3 »	<b>Lithium-base</b> grease N.L.G.I. No. 3

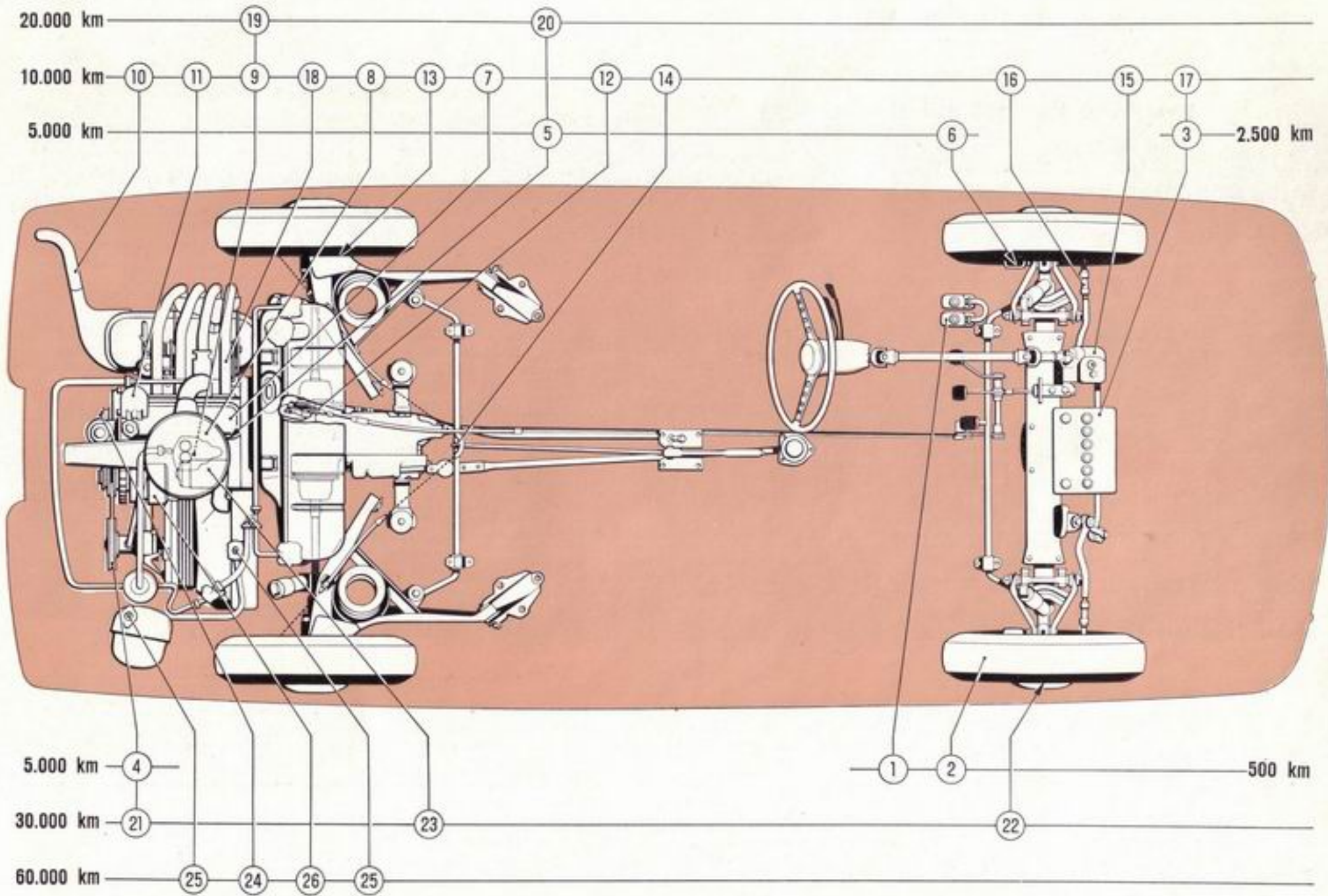

## CLEANING, INSPECTION AND ADJUSTMENT CHART

	See page		See page
<b>Every 500 km (300 miles) or weekly</b>			
1. Brake fluid reservoir: <i>Check level and top up as required</i> . . . . .	33	16. Wheel alignment: <i>Check and adjust</i> . . . . .	35
2. Tires: <i>Check pressure</i> . . . . .	35-45	— Tires: <i>Check for wear; rotate</i> . . . . .	35
<b>Every 2,500 km (1,500 miles) or monthly</b>		17. Battery: <i>Inspect posts and clamps</i> . . . . .	36
3. Battery: <i>Check electrolyte level</i> . . . . .	35	— Headlight aiming: <i>Check and adjust</i> . . . . .	37
<b>Every 5,000 km (3,000 miles)</b>		18. Exhaust silencer and lines: <i>Check mountings</i> . . . . .	40
4. Alternator, water pump and fan drive belts tension: <i>Check and adjust</i> . . . . .	31	— Seals, hoses, sleeves, connections: <i>Check tightness</i> . . . . .	40
5. Spark plugs: <i>Clean and check gap</i> . . . . .	32	<b>Every 20,000 km (12,000 miles)</b>	
6. Front brakes: <i>Check wear</i> . . . . .	33	19. Carburetor and crankcase emission control system: <i>Clean and wash</i> . . . . .	28
— Steering linkage articulations: <i>Check caps</i> . . . . .	34	20. Spark plugs: <i>Change plugs</i> . . . . .	32
— Windshield washer: <i>Check level, clean, adjust</i> . . . . .	40	— Mechanical units anchoring on body: <i>Check</i> . . . . .	40
<b>Every 10,000 km (6,000 miles)</b>		<b>Every 30,000 km (18,000 miles)</b>	
7. Valve tappets: <i>Check clearance</i> . . . . .	26	21. Alternator, water pump and fan drive belts: <i>Change belts</i> . . . . .	31
8. Air cleaner: <i>Change cartridge</i> . . . . .	27	22. Front wheel bearings: <i>Check and adjust play</i> . . . . .	35
— Fuel filter: <i>Change unit</i> . . . . .	27	23. Starter: <i>Clean commutator; inspect brushes</i> . . . . .	36
9. Carburetor: <i>Clean jets and strainer; check and adjust idle settings</i> . . . . .	28	<b>Every 60,000 km (36,000 miles)</b>	
10. Exhaust emission control system: <i>Check CO concentration</i> . . . . .	28	24. Centrifugal oil filter: <i>Clean</i> . . . . .	26
11. Ignition distributor: <i>Check points gap</i> . . . . .	31	25. Engine cooling system: <i>Change coolant</i> . . . . .	30
12. Clutch pedal play: <i>Check and adjust</i> . . . . .	32	26. Alternator: <i>Clean slip rings and inspect brushes</i> . . . . .	36
13. Rear brakes: <i>Check wear</i> . . . . .	33	<b>Other Service Dealer Operations</b>	
14. Hand brake: <i>Check effectiveness</i> . . . . .	33	— Valve gear timing checks . . . . .	27
15. Steering gear: <i>Check and adjust</i> . . . . .	34	— Ignition distributor breaker points replacement . . . . .	31
		— Ignition timing check . . . . .	32
		— Brake system check . . . . .	33
		— Hydraulic shock absorbers check . . . . .	34



## ENGINE LUBRICATION

**Every 500 km (300 miles) or weekly:** With engine cold, check oil level which must always result between the **Min** and **Max** marks on indicator rod, and top up if required.

**Note.** - Push the rod fully in to ensure good sealing of indicator rod handle ferrule on its seat in crankcase.

**Every 10,000 km (6,000 miles) \* or every six months at most:** Replace oil with engine **well warmed up.**

\* 5,000 km (3,000 miles) for stop-and-go (city) or dusty area operation.

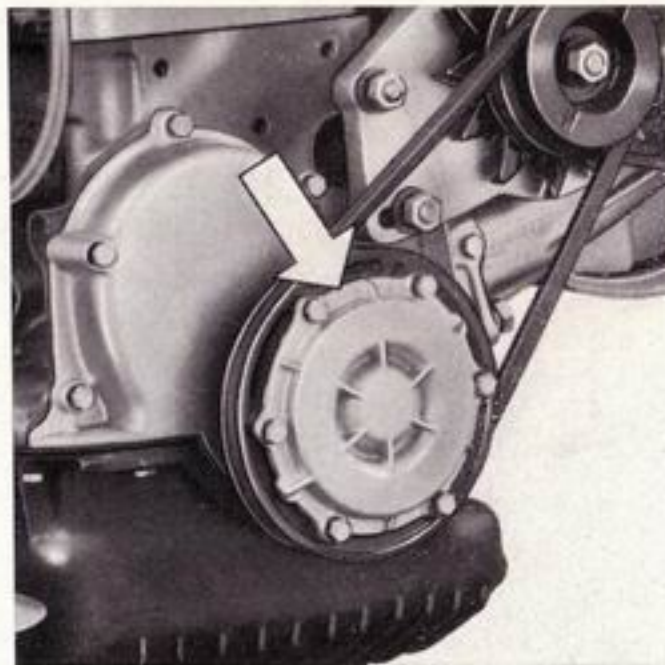

When engine is new, replace the oil after the first 1,000-1,300 miles and 2,500-3,500 miles – operation covered by Coupons **A** and **B** of the **Warranty Booklet.**

Oil replacements should of course be performed also in relation to the oil grade used (Single-grade or Multi-grade) shown on page 45.

### **Centrifugal Oil Filter**

Clean filter **at least every 60,000 km (36,000 miles) or sooner in cold climates and under heavy duty service.**

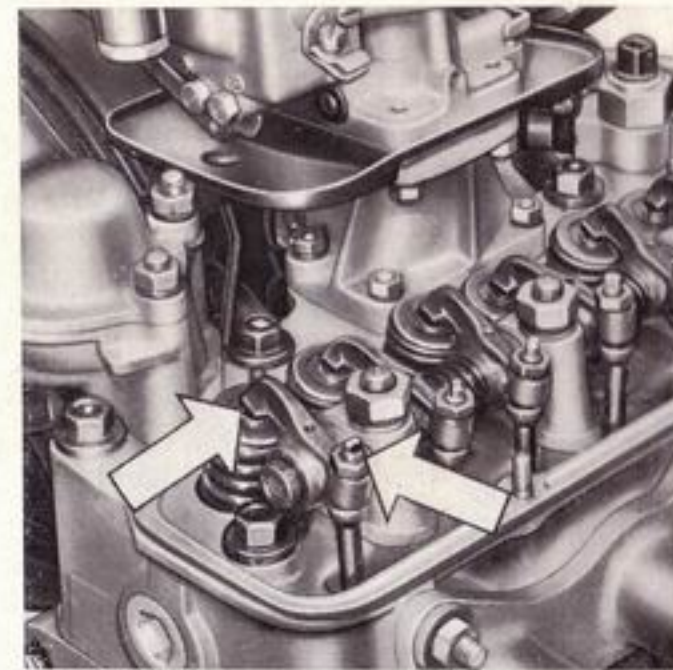

## VALVE GEAR

### **Valve Tappet Clearance**

**Every 10,000 km (6,000 miles) or** whenever tappet operation becomes noisy: Have the valve tappet clearance checked by a **FIAT Dealer**; specified clearance, **with cold engine**, is 0.15 mm (.006 in.) for intake and 0.20 mm (.008 in.) for exhaust valves.

**When engine is new**, valve tappet clearance must be checked after the

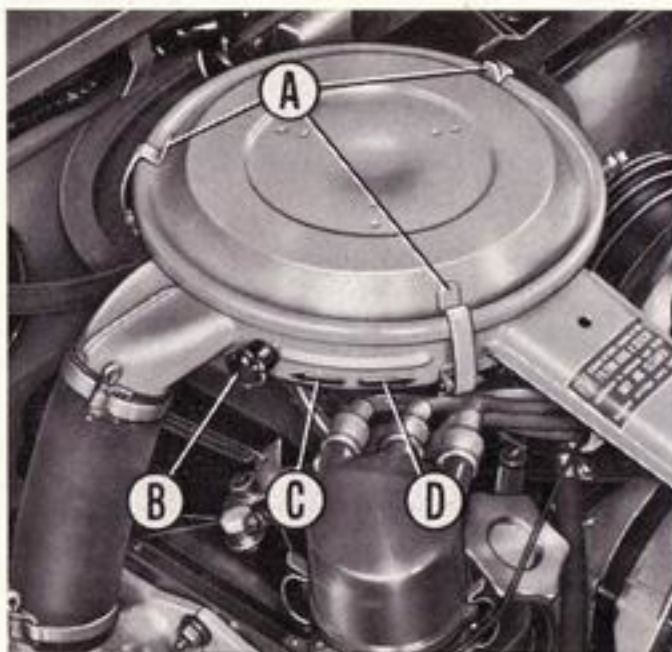
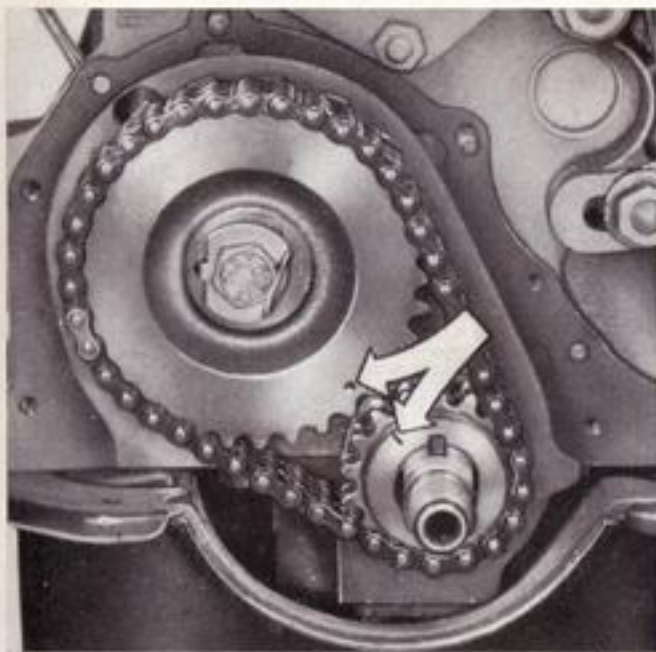

first 1,000 - 1,300 and 2,500 - 3,500 miles - Operation covered by Coupons **A** and **B** of the **Warranty Booklet**.

### Valve Timing

With reference marks lined up as shown timing is correct.



Whenever necessary, timing checks should be performed by a FIAT Dealer.

## FUEL SYSTEM

### Air Cleaner

**Every 10,000 km (6,000 miles):** Remove upper cover by lifting the three spring fasteners **A** and change the cartridge.

**When dusty conditions prevail,** change cartridge at every 5,000 km (3,000 miles) interval.

### Climatic Control

The cleaner has two separate air intakes, one for cooler air admission in summer and one for heated air in

winter. These are selected by knob **B** which should be pressed for easier maneuver.

*Summer:* shift knob in the direction of blue arrow **C** for admission of cooler air.

*Winter:* shift knob in the direction of red arrow **D** for admission of heated air.

### Fuel Filter

**Every 10,000 km (6,000 miles):** Disconnect filter unit from line and replace.

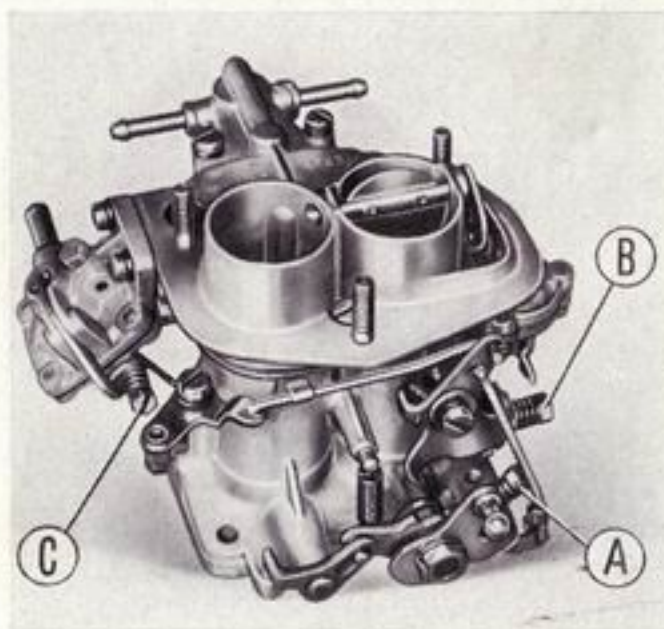

## Carburetor

### Every 10,000 km (6,000 miles):



Clean carburetor jets and inner strainer. This cleaning should be performed exclusively by using an air blast.

Next, adjust normal idle speed (\*) by turning throttle opening adjustment screw **A** and idle mixture metering screw **B** until engine speed is 800 to 900 RPM. To adjust fast idle rate (\*)

depress also button **D**, in engine compartment, which energizes the control electrovalve, and turn adjustment screw **C** until the idle speed is 1550 to 1650 RPM.

While button is kept depressed, pump the accelerator pedal several times, then check whether fast idle RPM rate has the correct value. If not, adjust again by screw **C** as directed above.

Performance of the above operations requires the necessary know-how. Always consult a FIAT Dealer when carburetor develops major troubles.

## Crankcase Emission Control System

### Every 20,000 km (12,000 miles):



Have the recirculation system, including carburetor, vent valve and flame trap, cleaned and washed with the proper solution.



## Exhaust Emission Control System

The exhaust emission control system is separate from crankcase emission control system and is designed to reduce air pollution from exhaust gases.

### Every 10,000 km (6,000 miles):



Have the CO concentration (\*) at normal idle checked for specified limit of  $2\% \pm 0,5\%$ .

\* When engine is new these settings are made when reporting for the service operations covered by coupons A and B of the Warranty Booklet.

## Fuel Evaporative Emission Control System

The release of fuel vapors from tank into the atmosphere, is prevented by a proper system through which they are conveyed to an activated carbon trap in engine compartment where they are adsorbed. During engine operation a hot air stream regenerates the activated carbon from which the gasoline vapors are extracted and conveyed to the intake manifold.

The system consists essentially of (see diagram) :

- Sealed filler cap.
- Limited-filling tank.
- Tank outlet line and vapor-liquid separators.
- Three-way valve performing the following tasks:
  - Slight tank pressurization.
  - Air inlet into tank to prevent any possible vacuum.
  - Safety exhaust to prevent undue overpressures in tank.

**A periodic visual inspection** of the condition of pipings and fittings is recommended.

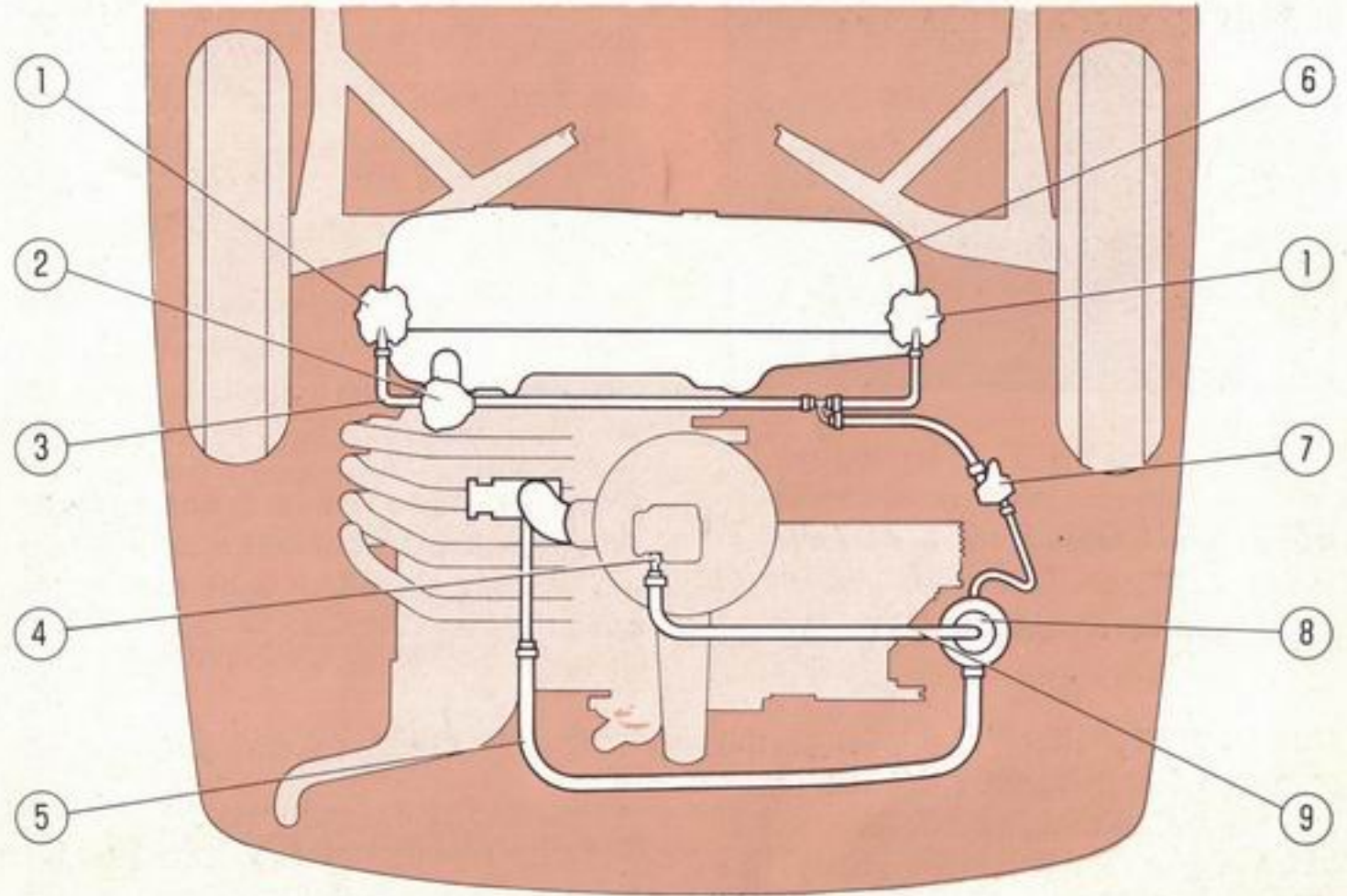

1. Vapor-liquid separators. - 2. Sealed filler cap - 3. Line inter-connecting the two vapor-liquid separators - 4. Calibrated orifice - 5. Hot air purge tube - 6. Fuel tank - 7. Three-way control valve - 8. Activated carbon trap - 9. Vapor vent line.



## **ENGINE COOLING SYSTEM**

### **Permanent Coolant Circuit**

**Occasionally** check the level of the permanent anti-freeze coolant in system expansion tank, **exclusively with cold engine**: level must always be above the « **MIN** » mark on tank. When engine is very hot the level might rise noticeably: this could also happen immediately after stopping the engine.

Should coolant level drop below the « **MIN** » mark on tank, top up with a 50-50 mixture of water and FIAT « **Parafu 11** » fluid (available at FIAT Dealers).

To top up, remove expansion tank cap and pour in the coolant mixture seeing that its level reaches about 7 cm (2<sup>3</sup>/<sub>4</sub> in.) above the « **MIN** » mark. Should more than two consecutive top-ups be required at short intervals or after limited mileages (less than 500 km = 300 miles), have the system checked by a FIAT Dealer.

**Only in case of an emergency** (sudden heavy coolant losses) can the system be filled with tap water operating as follows:

- Allow engine to cool down.
- Remove radiator and tank caps.
- Pour in water slowly through the expansion tank filler port until water overflows from radiator filler neck.

- Refit the radiator cap and complete the filling through expansion tank.
- Refit expansion tank cap.

In winter, after filling the system and before driving away, let the engine run for a while to ensure thorough mixing of the coolant.

Remember that with an addition of abt. 1.5 lt of plain water (3<sup>1</sup>/<sub>3</sub> U.S. Pts.) – equivalent to <sup>2</sup>/<sub>3</sub> the volume of the expansion tank – freezing point rises from -35°C (-31°F) to -23°C (-10°F).



**As soon as possible** have a FIAT Dealer repair the fault and refill with **permanent coolant**.

**Every 60,000 km (36,000 miles) or every 2 years**, whichever occurs first: Have the coolant replaced by a FIAT Dealer.



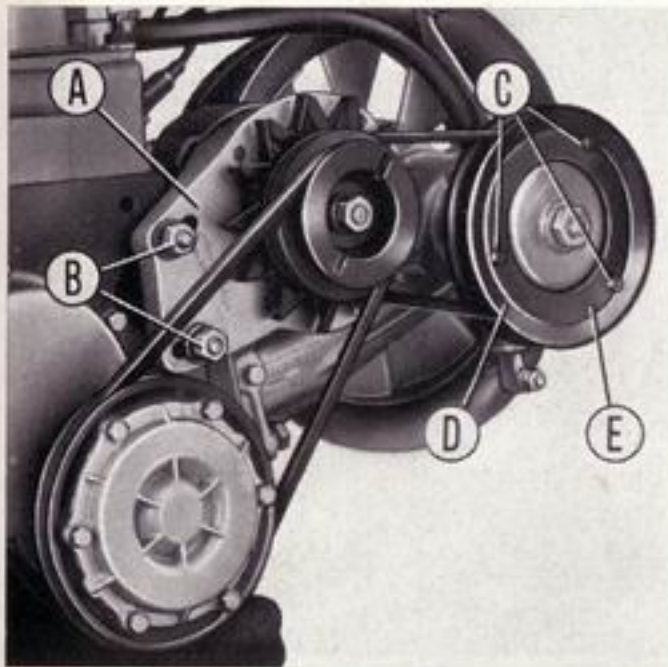

### **Alternator, Water Pump and Fan Drive Belts Tension**

#### **Every 5,000 km (3,000 miles) :**

 Have drive belts checked for proper tension which is correct when under a pressure of about 10 kg (22 lbs.) belt sag is 1 to 1.5 cm ( $\frac{1}{3}$  to  $\frac{1}{2}$  in.).

**Every 30,000 km (18,000 miles) :**  
Have belts changed.

To stretch the belts, proceed as follows :

#### **Alternator Drive Belt :**

— Slacken the two nuts **B**.

— Shift support **A** outwards until tension is correct. Retighten support nuts **B**.

#### **Water Pump and Fan Drive Belt :**

- Back out the three pulley-to-hub mounting nuts **C**.
- Remove outer semi-pulley **D**, take out one (or more, depending on belt slackness) of the spacer rings forming the pulley groove.
- On re-installing the pulley, rings **E** - if more than one was removed - should be suitably distributed on the two outer faces of the pulley.
- Secure pulley by the three nuts **C**.

## **IGNITION SYSTEM**

### **Ignition Distributor**

#### **Every 10,000 km (6,000 miles) :**

Remove cap and rotor, then with a few drops of the same oil used in engine wet wick **B**.

Furthermore, check breaker point gap **C** which must be 0.37 to 0.43 mm (.015 to .017 in.); adjustments are

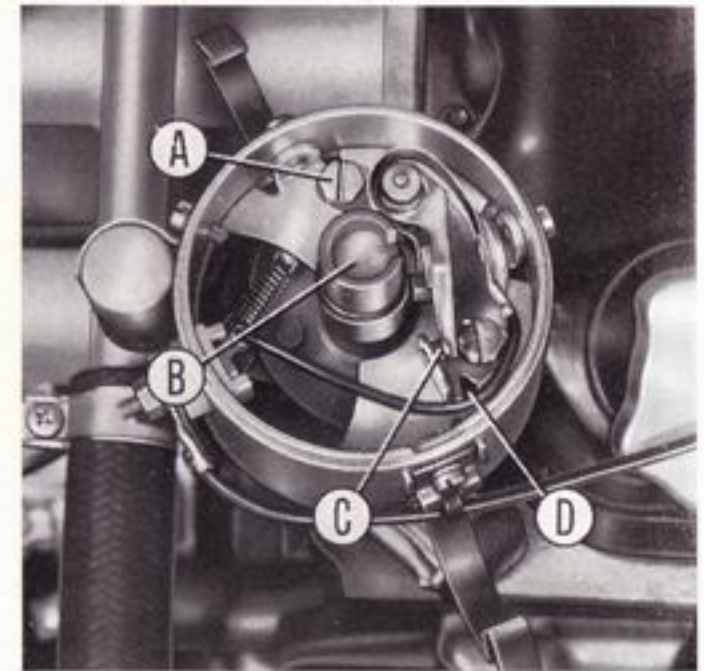

made by slackening screw **A** and shifting the contact carrier plate as required by a screwdriver tip inserted in slot **D**, then re-locking screw **A**.

If contacts are dirty (oily) wipe with a gasoline-moistened cloth.

 After setting breaker point gap adjust also engine idle speed rates.

Following repeated adjustments, or sooner if required, replace contacts.

**With new engine,** at 1,000 to 1,300 and 2,500 to 3,500 miles (Coupons **A** and **B**) have the dwell angle checked ( $55^\circ$  at 800 to 900 rpm).



### **Spark Plugs**

**Every 5,000 km (3,000 miles):** Clean spark plugs by removing all deposits also in the recess between central electrode porcelain liner and body (or better have them sanded) and check if electrode gap **A** is as specified: 0.5-0.6 mm (.020-.024 in.). (See « Safe Motoring Hints »).

**Every 20,000 km (12,000 miles):** Fit new spark plugs.

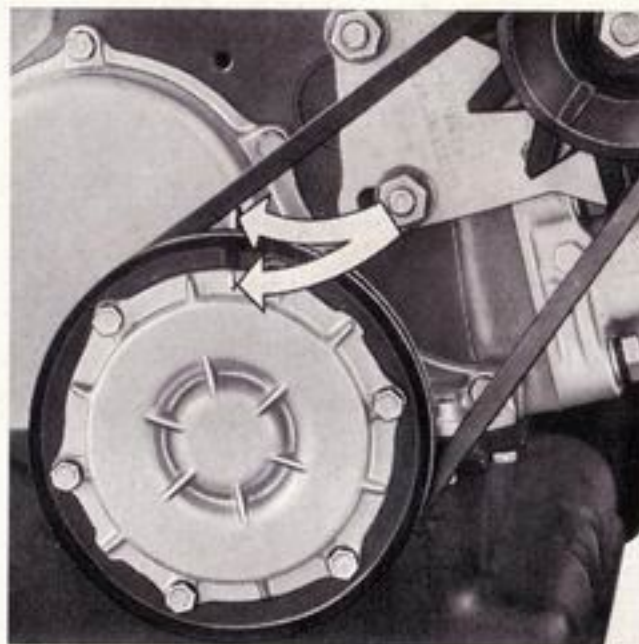

### **Ignition Timing**



This timing is necessary when the camshaft and/or distributor have been removed.

**With new engines** this check is performed at 1,000-1,300 and 2,500-3,500 mile intervals (Coupons **A** and **B**) of the Warranty Booklet.



### **POWER TRAIN**

#### **Clutch Pedal Free Travel**

**Every 10,000 km (6,000 miles):** Have the clutch pedal free travel checked and adjusted to abt. 25 mm (1 in.).



#### **Transmission and Axle Oil**

**Every 10,000 km (6,000 miles):** Check oil level which must reach plug bottom edge.

**Every 30,000 km (18,000 miles):** Renew oil. Let drip thoroughly before refilling.

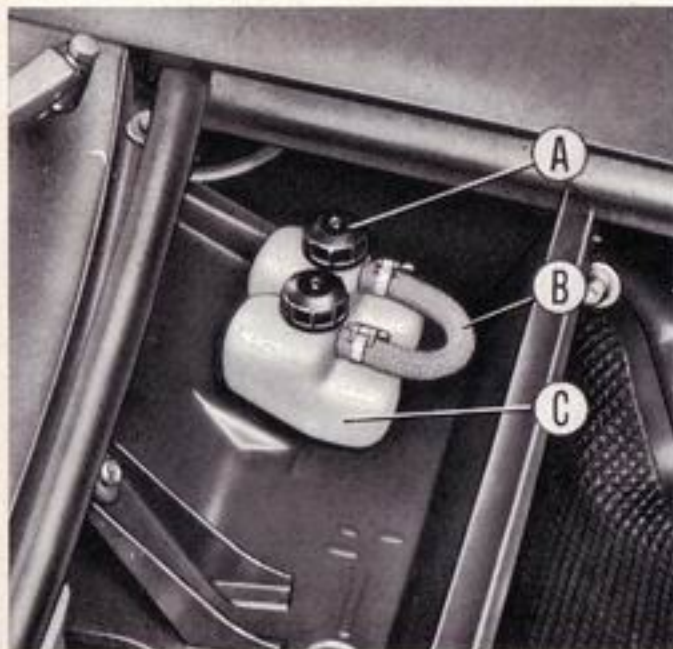

## BRAKES



If pedal free travel has become excessive, if braking unbalance on one wheel is appreciable or if pedal sponginess is felt with consequent reduced brake effectiveness, a complete inspection of the system should be performed by a FIAT Dealer.

**Every 5,000 km (3,000 miles)** - front brakes - and **10,000 km (6,000 miles)** - rear brakes - check that the pads or linings have not worn down to **less than 1.5 mm (.06 in.)**; replace as required.

Shield brakes as much as possible when oil spraying the car bottom. Any other operation concerning the brake system should be performed exclusively by a FIAT Dealer.

Brake system with front and rear independent circuits.

Two separate fluid reservoirs: one for each circuit.

### Brake Fluid Reservoirs

- A.** Front brake hydraulic circuit fluid reservoir.
- B.** Reservoir interconnection hose.
- C.** Rear brake hydraulic circuit fluid reservoir.

**Every 500 km (300 miles) or weekly:** Check level and, if required, top up. Use exclusively **SAE J 1703/b** (Heavy Duty non-mineral grade) fluid.

### Bleeding



In case brake system has been drained the circuit must be bled after refilling with the

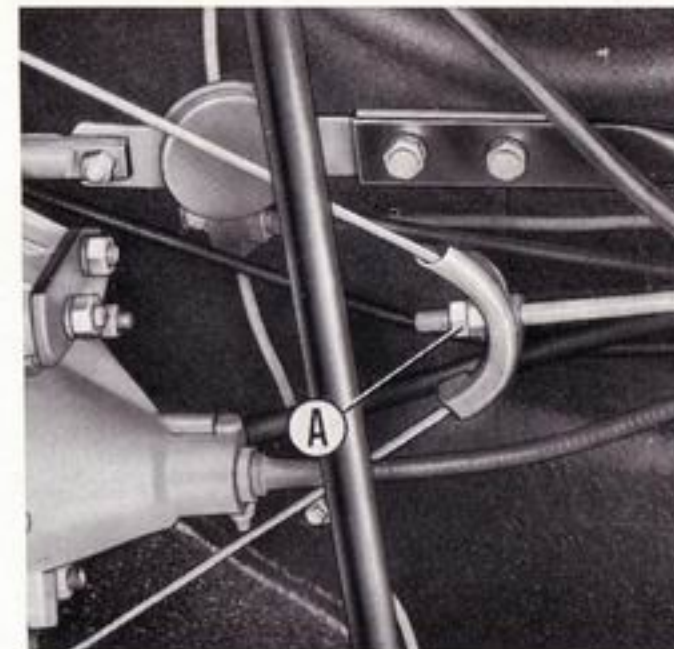

specified **brake fluid**; pump the pedal repeatedly to bleed the system. This is a very delicate operation and should be entrusted to a FIAT Dealer.

### Hand Brake

**Every 10,000 km (6,000 miles)** or sooner:



If with hand brake lever pulled fully up the car is not sufficiently braked, it will be necessary to adjust the control rope through its stretcher **A**.

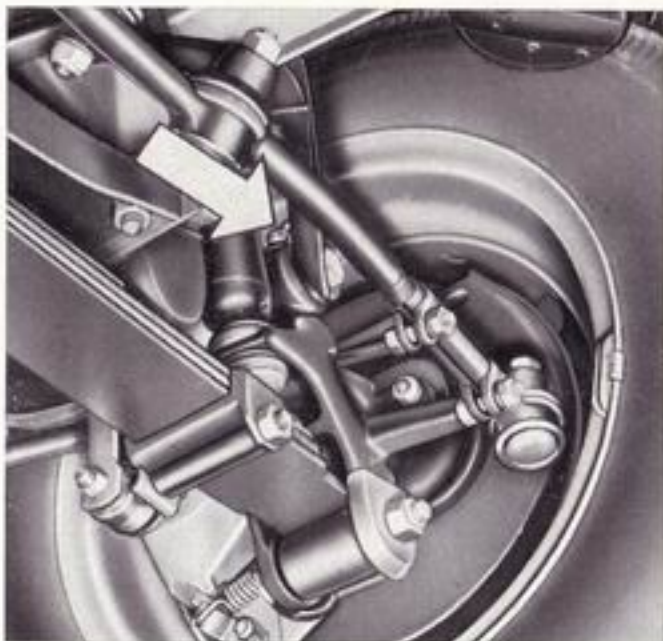

## **SUSPENSION**

### **Kingpins**

**Every 5,000 km (3,000 miles):** Inject some FIAT **Jota 1** grease in lubricator on top of each pin housing.

### **Hydraulic Shock Absorbers**



Whenever damping action becomes irregular have shock absorbers inspected.

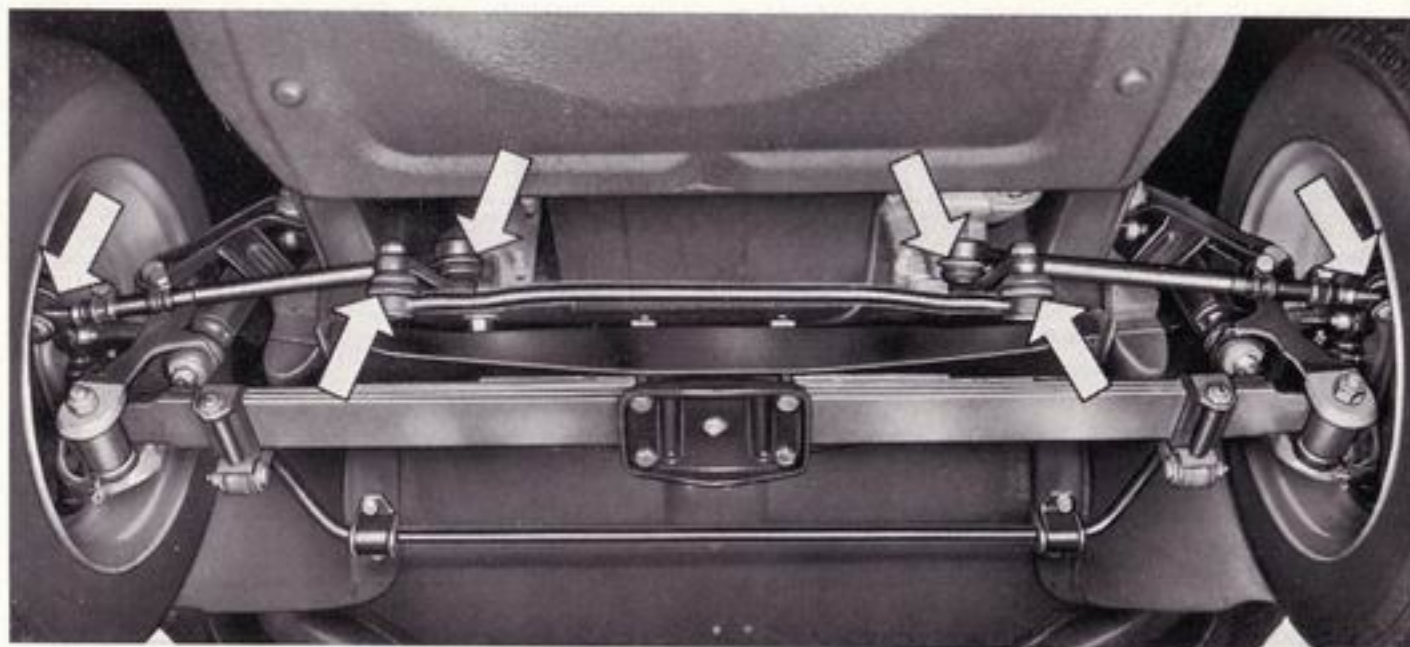

## **STEERING AND WHEELS**

### **Steering Linkage Articulations**

**Every 5,000 km (3,000 miles)** or whenever inspections to the chassis are carried out, **check the condition of ball joint rubber caps.**



If rubber caps are damaged, they should be replaced. The new caps should be packed with FIAT **MR 3** grease prior to their

installation. At the same time inspect ball joints for excessive play. If evidence of looseness exists, replace the ball joint.

**Proper ball joint maintenance is essential for car safety.**

### **Steering Gear Adjustments**

**Every 10,000 km (6,000 miles):** Have steering mechanism inspected and adjusted by a FIAT Dealer.



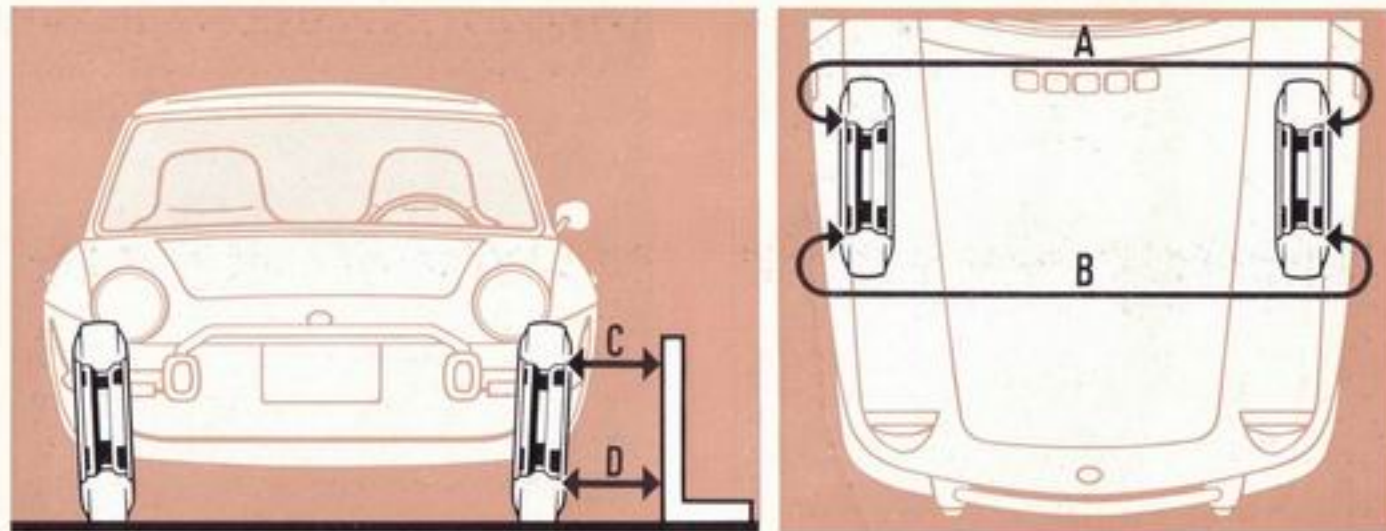

### Front Wheel Bearings

Every 30,000 km (18,000 miles):



Have the bearings lubricated with FIAT MR 3 grease and adjusted by a FIAT Dealer.

### Rear Wheel Bearings

Every 30,000 km (18,000 miles):



Have the bearings lubricated with FIAT MR 3 grease by a FIAT Dealer. No adjustment is required.

### Camber

$D = C + 12$  to 16 mm (.47 to .63 in).

The above data apply to the car laden to an equivalent of 2 adults (300 lbs) plus 10 kg (22 lbs) in front compartment and 40 kg (88 lbs) in recess behind seats.

### Wheel alignment

Every 10,000 km (6,000 miles)

or sooner if irregular wear of front wheel tires is noticed: Have **toe-in** and **camber** checked and adjusted as required. - See check data in the figures above.



### Toe-in

$A = B + 2$  to 4 mm (.08 to .16 in).

### Tires

Every 500 km (300 miles) or weekly: Check pressure with a gage, not forgetting the spare wheel. Rubber lugs are provided in tread grooves to serve as visual wear indicators: when tire is worn down to their level it should be replaced.

**Note.** - See « Safe Motoring Hints » for instructions on how to equalize tire wear.

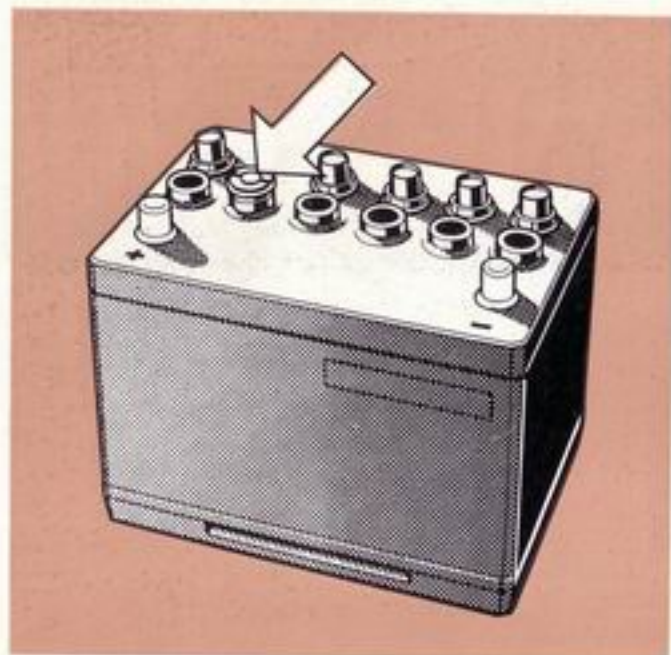

## ELECTRIC SYSTEM

### Battery

Located in front compartment (see page 19).

An indicator, called the « Delco Eye », glows to warn that electrolyte level is low: in this case, check level in each cell and top up with **distilled water**.

**Every 2,500 km (1,500 miles)** or monthly: With battery at rest and cold, check the indicator.

**In summer**, check the indicator more often.

**Every 10,000 km (6,000 miles):** Check posts and clamps for tightness and cleanliness. To reach battery lift the front compartment mat, back out the two knobs and lift protection cover. If car must be garaged for a considerable time, see « *Safe Motoring Hints* ».

### Alternator

**Every 60,000 km (36,000 miles)(\*):**  
 Clean slip rings carefully with a dry cloth; check brushes for wear and contact conditions and replace the complete brushholder.

### Starter

**Every 30,000 km (18,000 miles)(\*):**  
 Clean and check commutator; replace the brushes. On this occasion, lubricate freewheel components exclusively with **FIAT MR 2** grease and the drive unit helical splines with **FIAT VS 10W** oil.

\* If car is driven in prevalingly dusty areas, this operation should be performed at half this interval.

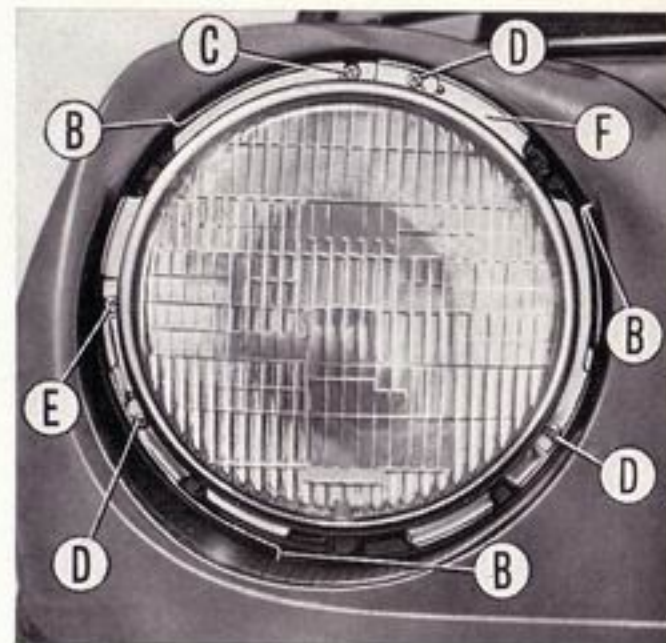

### Headlights

To reach headlight unit first pry off the frame using the tip of a screwdriver.

- B.** Frame spring fasteners (three).
- C.** Beam vertical aiming adjustment screw.
- D.** Screws (three) to be slackened to permit counterclockwise rotation and removal of retainment ring **F**.
- E.** Beam horizontal aiming adjustment screw.

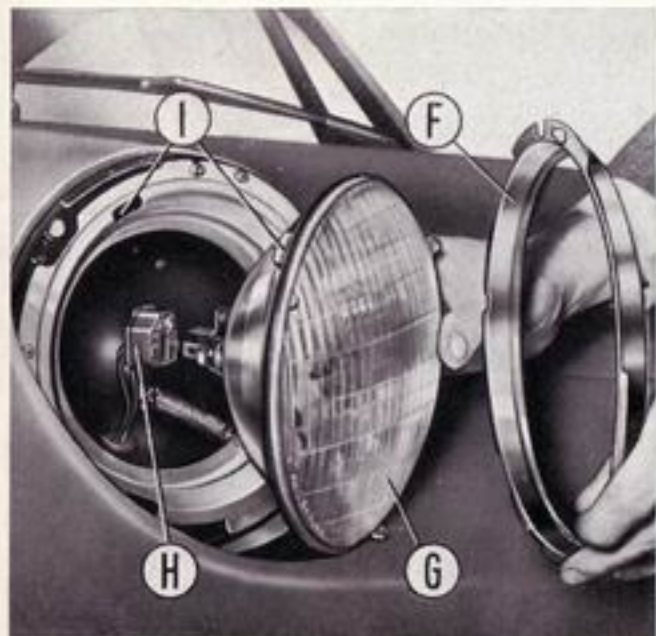

- F. Headlight unit retainment ring.
- G. Headlight unit.
- H. Terminal socket.
- I. Headlight unit location dowel and slot (three).

### **Headlight Aiming**

**Every 10,000 km (6,000 miles):** For headlamp aiming proceed as recommended in applicable SAE Standards.

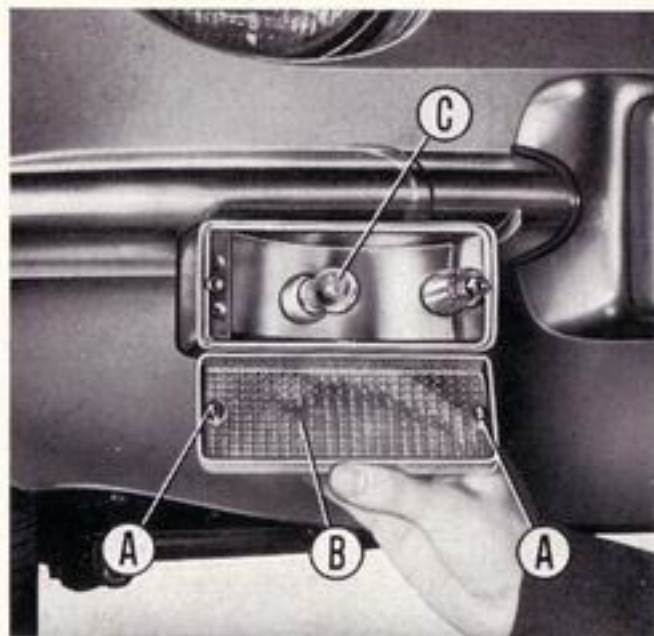

### **Front Parking and Turn Signal Lamps**

- A. Lens mounting screws.
- B. Lens.
- C. Bayonet-coupled bulb.

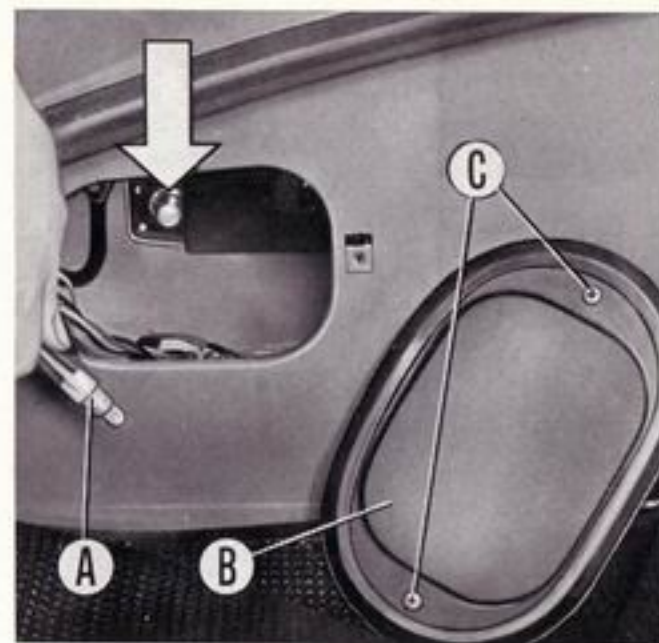

### **Side Marker Lamps**

Access to the pressure-mounted bulb holder **A** is gained through front luggage compartment (see figure) - or engine compartment for rear markers - after removing lid which is secured in position by two screws **C**. Bulbs are of the wedge-base type.

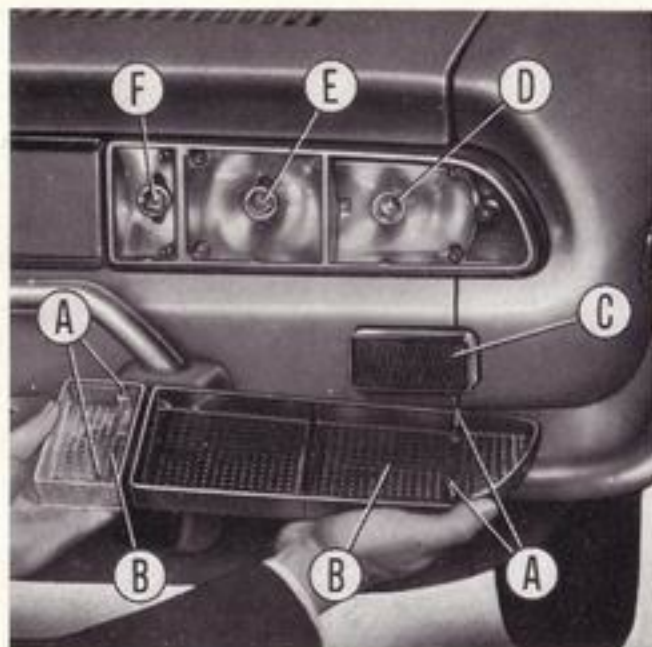

### ***Rear Tail, Stop, Turn Signal and Back-up Lamps***

- A.** Lens fixing screws (four).
- B.** Lenses.
- C.** Reflex reflector.
- D.** Bayonet-coupled bulb, turn signal light.
- E.** Bayonet-coupled, double-filament bulb, tail and stop lights.
- F.** Bayonet-coupled bulb, back-up light.

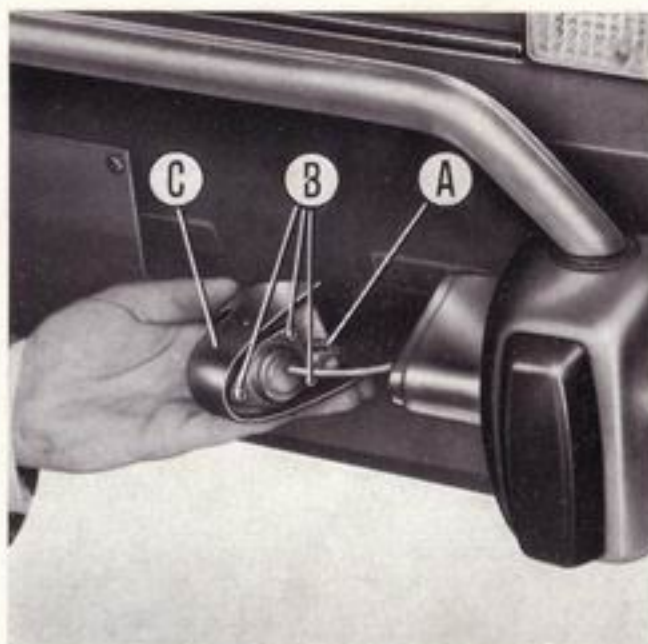

### ***License Plate Lamps***

- A.** Screw, fixing the lamp to bumper (accessible through illumination slots).
- B.** Screws (three), fixing the bulbholder (with bayonet-coupled bulb) and lens to lamp body.
- C.** Lamp unit, snap-mounted and locked by screw **A**.

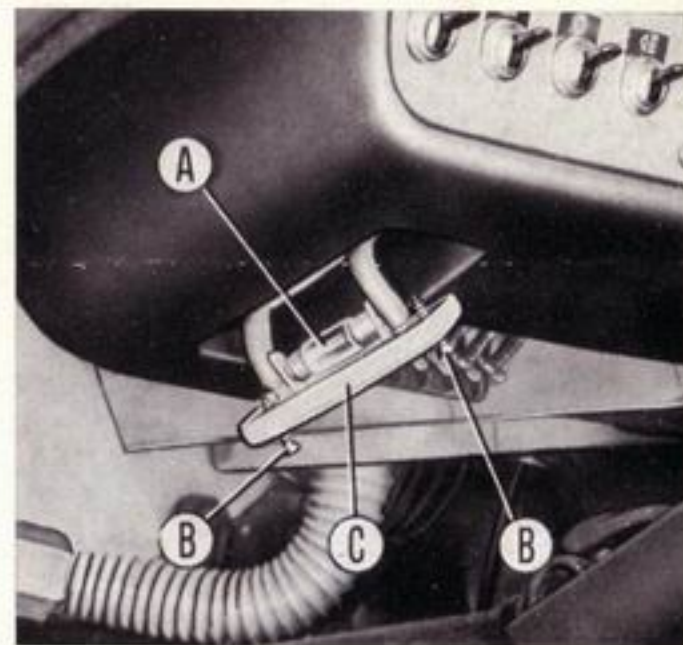

### ***Courtesy Lights***

- A.** Bulb, cylindrical.
- B.** Lamp unit fixing screws.
- C.** Lens and bulbholder assembly.



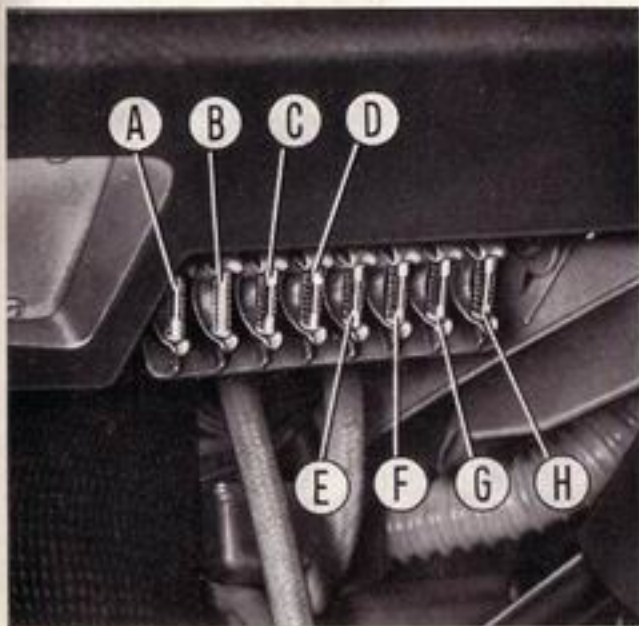

## PROTECTED CIRCUITS:

### A (8-Amps)

Oil pressure gage and relevant insufficient pressure indicator.  
 Engine water temperature gage.  
 Fuel gage and reserve indicator.  
 Turn signal lights and indicator.  
 Stop lights.  
 Engine tachometer.  
 Brake system effectiveness indicator.  
 Back-up lights.  
 Heater fan motor.  
 Windshield wiper motor.  
 Battery charge indicator.  
 Exhaust emission control electrovalve.  
 Fasten belts indicator and buzzer.

### B (16-Amps)

Courtesy lights under dash.  
 Horns and relevant relay switch.  
 Cigarette lighter.  
 Vehicular hazard warning signal circuitry.

### C (8-Amps)

Left headlight high beam.  
 High beam indicator.

### D (8-Amps)

Right headlight high beam.

### E (8-Amps)

Left headlight low beam.

### F (8-Amps)

Right headlight low beam.

### G (8-Amps)

Front left parking and side marker lights.  
 Parking and tail lights indicator.  
 Rear right tail and side marker lights.  
 License plate light (left).

### H (8-Amps)

Front right parking and side marker lights.  
 Rear left tail and side marker lights.  
 License plate light (right).  
 Instrument cluster lights.  
 Cigarette lighter housing indicator.

### In separate holder (8-Amps)

Voltage regulator.  
 Alternator field winding.

### In separate holder (3-Amps)

Remove key buzzer.

## Fuses

Seven 8-Amp fuses and one 16 Amp fuse, contained in a fuse box located under instrument panel to the left of steering post.

One 8 Amp fuse and one 3 Amp fuse in separate holders.

Before replacing a burnt fuse trace the cause of blowing, and remedy accordingly.

**Unprotected circuits:** ignition, starting, and battery charge (except indicator, voltage regulator and alternator field winding).

## MISCELLANEA

**Every 10,000 km (6,000 miles):**  
Lubricate as required the following items, using the recommended products:

- Door lock cylinders with **graphite powder**.
- Door hinges and front seat reclinable squab articulations, with **engine oil**.
- Window venti-pane joints and hinges with **glycerine**.
- Trunk lid and engine hood catches, and hinges with **petroleum jelly**.
- Seat guide rails with **FIAT Jota 1** grease.

Additionally, check positive mounting of exhaust silencers, manifold and resilient brackets.

Also, check proper tightness of all gaskets, seals, rubber hoses, sleeves, plugs, etc. and that pipe joints are secure.

**Every 20,000 km (12,000 miles):**  
Have the mechanical units to body anchorings checked for proper tightness.



All these specified intervals are dependent upon car service severity (extremely cold climates, bumpy and dusty roads, prolonged exposure to atmospheric agents, etc.)

### Windshield Washer

**Every 5,000 km (3,000 miles):**  
Check level in bottle.

- Clean gauze filter on the suction end of outlet pipe in bottle, on engine compartment left side.

In case of incorrect jet aiming:

- Adjust by inserting a suitably sized needle or steel wire first in one jet orifice, and then in the other, to re-position in turn the two balls until the water squirt of each hits the top of its wiper sweep arc.

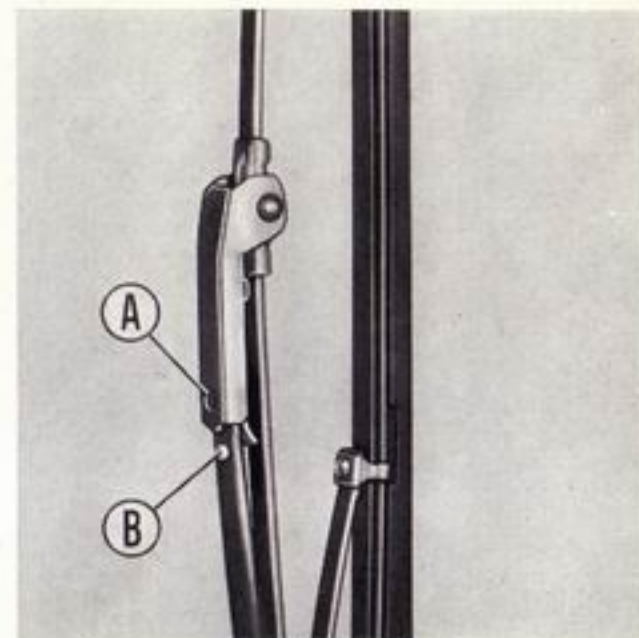

### Windshield Wiper

To remove a wiper blade, tilt out the arm, free the blade mount **A** from its lock dowel **B** on arm and remove blade upwards.

### Tool kit

The tool box contains:

- Wrench, socket, spark plugs.
- Wrench, double end, 8 x 10 mm.
- Wrench, double end, 13 x 17 mm.
- Screwdriver, double-tipped.
- Punch, straight.
- Speed handle, wheel fixing screws (and wheel cap removal).

# SPECIFICATIONS

## ENGINE

Type . . . . .	100 GBS.040
Location . . . . .	rear mounted
Number of cylinders, in line . . . . .	4, vertical
Bore and stroke . . . . .	65 x 68 mm (2.56 x 2.68 in.)
Total piston displacement	903 cc (55.08 cu. in.)
Compression ratio . . . . .	9.5 to 1
Engine rotation	counterclockwise
Max. power SAE net . . . . .	49 HP

## VALVE GEAR

Overhead valves.  
Camshaft in crankcase.  
Timing data:

Intake	Opens: B.T.D.C.	25°
	Closes: A.B.D.C.	51°
Exhaust	Opens: B.B.D.C.	64°
	Closes: A.T.D.C.	12°

Tappet clearance adjustment for valve timing . . . . . 0.375 mm (.012 in.)

Final tappet operation clearance adjustment, **with cold engine** :  
intake . . . . . 0.15 mm (.006 in.)  
exhaust . . . . . 0.20 mm (.008 in.)

## LUBRICATION

Forced, by gear pump; pressure relief valve.

Normal lubrication pressure 3 to 4 kg/cm<sup>2</sup> (42.6 to 57 p.s.i.)

Thorough oil cleaning by full-flow centrifugal filter.

Light-alloy sump.

## FUEL SYSTEM

**Carburetor: Weber type 30 DICA 1** dual-barrel carburetor, with differential opening of throttles, progressive-action starting device (manual choke) and accelerating pump. A vacuum bellows

controls the partial opening of the 1st barrel throttle from the idling position (fast idle operation setting adjustments).

Fuel filter in the feed line from pump to carburetor,

Engine feed system equipped with a fuel recirculation system (closed circuit).

Paper cartridge air cleaner with silencer.

Crankcase emission control system by recirculation of blow-by gases and oil vapors.

Exhaust emission control device (to reduce air pollution from exhaust gases) separate from crankcase emission control system.

## COOLING

Permanent coolant (water, glycols and inhibitors mixture) in pressurized system. Freezing point: less than -35°C (-31°F).

Centrifugal pump.

Thermostat in engine coolant outlet duct.

Axial flow radiator fan.

## IGNITION SYSTEM

Firing order . . . . .	1-3-4-2
Basic ignition timing . . . . .	0° (TDC)
Automatic advance . . . . .	38°
Dwell angle, for distributor contacts gap check (at 850 RPM) . . . . .	55°
Ignition point gap	0.37-0.43 mm (.015-.017 in.)
Spark plugs	<b>Champion N 6 Y</b> or <b>AC Delco 41-2XLS</b>
diameter and pitch	14 x 1.25 mm
gap	0.5-0.6 mm (.020-.024 in.)

## POWER TRAIN

### CLUTCH

Single plate, dry, with disc spring, mechanically operated by pedal.  
Pedal free travel: abt. 25 mm (1 in.).

### TRANSMISSION AND DIFFERENTIAL

4 forward speeds (all synchronized) and reverse. Gear ratios to 1:

1st	2nd	3rd	4th	Reverse
3.636	2.055	1.409	0.963	3.615

Differential and final drive gears in transmission casing.  
Hypoid final drive, ratio . . . . . 8 to 39  
Drive to rear wheels by half-axle swing shafts with slip-joints at differential and flexible joints at wheels.

## BRAKES

### Service

Hydraulically operated by pedal through master cylinder.

Front: disc type, with floating caliper and one cylinder to each wheel.

Rear: self-centering, expanding-shoe drum type, with one cylinder to each wheel.

Automatic wear take up at front and rear.

### Parking and emergency

mechanical, hand controlled, operating on rear wheel shoes.

## SUSPENSION

### FRONT SUSPENSION

Independent wheels, with swinging arms and hydraulic shock absorbers.

Semielliptic spring: transversally mounted, anchored at center to one body cross beam and at the ends to the kingpin housings.

Stabilizer bar connected to leaf spring.

## REAR SUSPENSION

Independent wheels with coil springs and swinging arms.

Hydraulic shock absorbers.

Stabilizer bar connected to swinging arms.

## STEERING AND WHEELS

### STEERING

Position . . . . . L.H.D.  
Control by worm screw and sector;  
ratio . . . . . 2/26

Steering shaft supported on two ball bearings and provided with two universal joints.

Independent and symmetric track rods to each wheel.

Turning circle diameter . . . . . 9.60 m  
(31 ft 6 in.)

Front wheel camber, measured  
at rim . . . . . 12-16 mm  
(.47-.63 in.)

Front wheel toe-in, measured  
at rim . . . . . 2 to 4 mm  
(.08 to .016 in.)

### WHEELS AND TIRES

Disc wheels, with rim size . . . . . 5J x 13"  
Radial tires, size . . . . . 155SR-31"

## ELECTRIC SYSTEM

Tension . . . . . 12 volts

### ALTERNATOR

Max output (14.5 V - 53 Amps) 770 W

Incorporated current rectifiers.

Automatic voltage regulator.

Cut-in speed at starting of engine (all users off).

### BATTERY

capacity at 20-hr discharge rate : 50 Amp/hr.

Cold (— 18° C) high-discharge test current . . . . . 185 Amps

### STARTER

Power . . . . . 0.50 kW

Direct engagement by solenoid and free-wheeling pinion.

### FUSES

Eight of 8 Amps, one of 16 Amps, and one of 3 Amps.

## BULBS

Location	SAE designation	FIAT designation
Headlights (high and low beams)	« Sealed beam » headlamp unit 6012	
Front lamps { turn signal . . . . . parking . . . . . }	No. 1034-12V-32/3 cp	12V-5/21W FIAT Norm. 1/41461/90
Rear lamps { stop . . . . . tail . . . . . }		
Rear lamps { turn signal . . . . . back-up . . . . . }	No. 1073-12V-32 cp	12V-21W FIAT Norm. 1/41460/90
License plate lamps . . . . .	No. 67-12V-4 cp	12V-5W FIAT Norm. 1/41459/90
Courtesy lights . . . . .	—	12V-5W FIAT Norm. 1/08630/90
Instrument panel lights . . . . .	No. 158-12V-2 cp	12V-3W FIAT Norm. 1/41458/90 or Norm. 1/41439/90
Turn signal indicator . . . . .		
Headlight high beam indicator . . . . .		
Battery charge indicator . . . . .		
Insufficient oil pressure indicator . . . . .		
Fuel reserve indicator . . . . .		
Parking and tail lamps indicator . . . . .		
Vehicular hazard warning signal pilot light . . . . .		
Brake system effectiveness indicator . . . . .		
Cigarette lighter housing indicator . . . . .		
Fasten belts indicator . . . . .		
Side marker lamps . . . . .		

## MAIN DIMENSIONS

mm.	495	877	920	1170	1220	1222	1498	2027	3824
in.	19.5	34.5	36.2	46.1	48	48.1	59	79.8	150.5

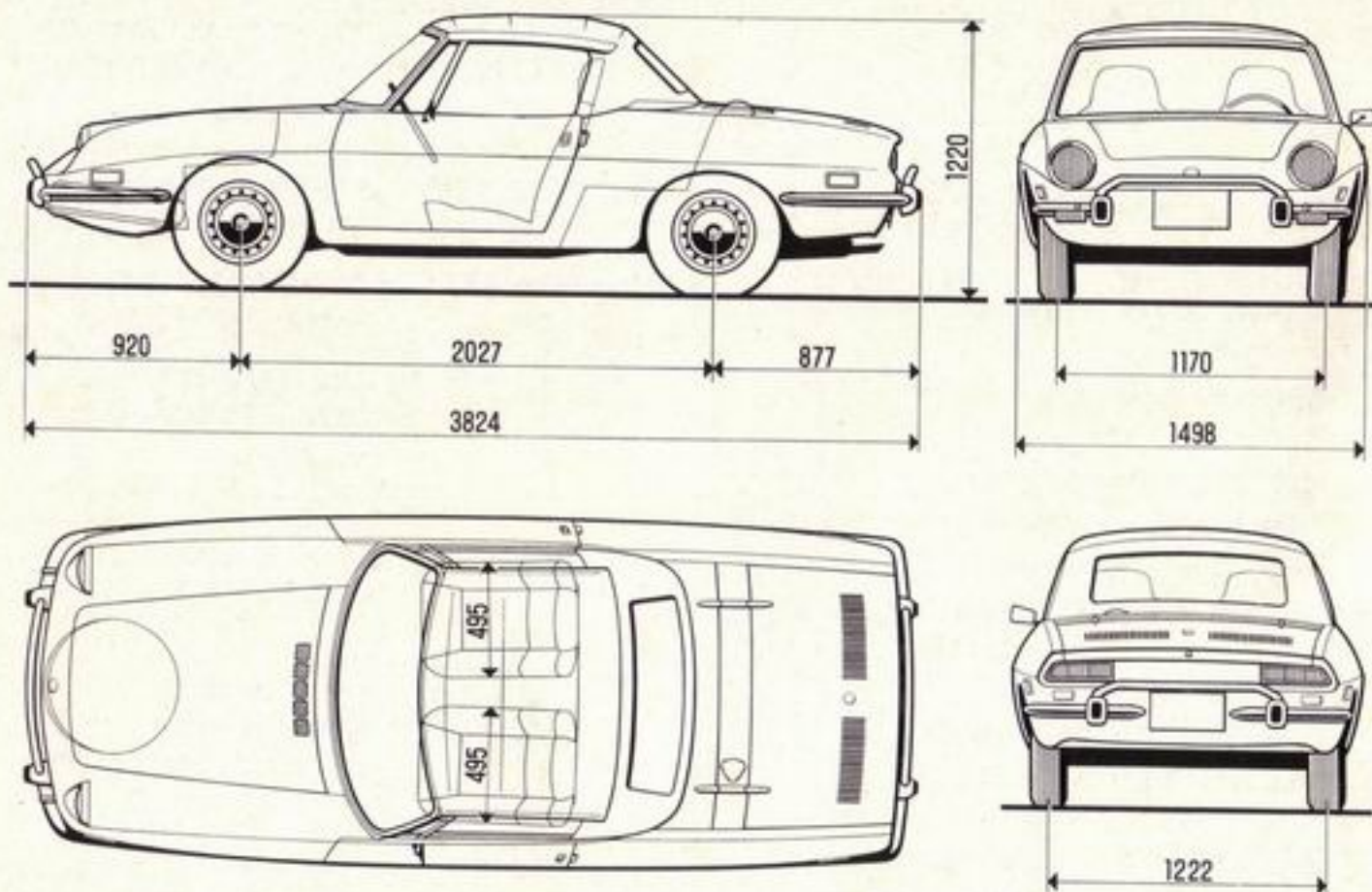

## PERFORMANCE

### SPEEDS

maximum speeds after break-in, fully laden:

first gear . . .	40 km/h (25 m.p.h.)
second gear . . .	70 » (44 » )
third gear . . .	105 » (65 » )
fourth gear over	150 » (93 » )

### CLIMBABLE GRADIENTS

maximum, fully laden:

first gear . . . . .	38%
second gear . . . . .	20%
third gear . . . . .	12%
fourth gear . . . . .	7%

### WEIGHTS

Curb weight . . . lbs.  
 Vehicle load capacity:  
 2 adults (300 lbs) +  
 + 130 lbs of luggage  
 (total 430 lbs.)  
 Total weight (fully  
 laden) . . . . . lbs.

	Fabric Top	Hard Top
Curb weight . . . lbs.	1650	1675
Total weight (fully laden) . . . . . lbs.	2080	2105

Designated seating capacity . 2 persons  
 Occupant distribution . . . . 2 in front

The height is for unladen car. With Hard Top max. height is 1205 mm (47.4 in).

## FILL-UP DATA

	lt	kg	U.S. units.	
Fuel tank . . . . .	28	—	7 <sup>2</sup> / <sub>5</sub> Gals.	Premium gasoline
Radiator, cylinder jackets and heating system . . . . .	7.5	—	8 Qts.	50-50 mixture of water and FIAT « Paraflu 11 » (1) fluid or equivalent
Engine sump and filter (2) .	4	3.825	4 <sup>1</sup> / <sub>2</sub> »	See table below
Transmission and differential .	2.1	1.9	4 <sup>1</sup> / <sub>2</sub> Pts.	} SAE 90 EP oil meets MIL-L-2105 B requirements
Steering box . . . . .	0.12	0.11	1/4 »	
Brake control hydraulic { front system . . . . . rear	0.19	0.19	2/5 »	} Heavy-Duty Brake Fluid meeting SAE J 1703 b requirements
	0.17	0.17	1/3 »	
Windshield washer bottle . .	Temperature		Solvent in bottle	Pure water plus high quality windshield washer solvent
	above 0° C (32° F)		3 %	
	down to -10° C (14° F)		50 %	
	below -10° C (14° F)		100 %	

(1) This mixture of water and **FIAT « Paraflu 11 » liquid** offers anti-oxidizing, rust-inhibiting, anti-foaming and anti-scaling properties and does not freeze down to -35 °C (-32 °F).

(2) Total capacity of sump, filter and lines is 4.1 kg (4<sup>2</sup>/<sub>3</sub> U.S. qts.).

The amount indicated in the Table is the requirement for periodic oil changes.

Outdoor temperature		FIAT Single-grade oil	FIAT Multigrade oil
		Low-ash content detergent oils-API Service SD, CC - meeting the European Sequence	
Minimum below -15° C (5° F)		<b>VS 10 W</b> (SAE 10 W)	—
Minimum between -15° and 0° C (5° F to 32° F)		<b>VS 20 W</b> (SAE 20 W)	<b>10 W - 30</b>
Minimum above 0° C (32° F)	Max. up to 35° C (95° F)	<b>VS 30</b> (SAE 30)	<b>20 W - 40</b>
	Max. over 35° C (95° F)	<b>VS 40</b> (SAE 40)	

Never top up with oils of other grades. For recommended oil properties, see « Safe Motoring Hints ».

## Tire pressures

Front . . . . .	20 psi
Rear . . . . .	26 psi

**Note - To obtain the required safety in car performance strictly adhere to the pressure ratings given. Tire inflation pressures should be checked with cold tires.**

The descriptions and illustrations appearing in this book are not binding. FIAT, therefore, reserves the right—while retaining the basic features of the Model herein described and illustrated—to make at any time, and without necessarily bringing this book up to-date, any alteration to units, parts or accessories deemed expedient for any technical, manufacturing or commercial reason.

FIAT — SERVIZIO NORME E PUBBLICAZIONI  
Corso G. Agnelli, 200 — 10100 TORINO - Italia  
3rd Ed. - Print No. 603.01.507 - XI-1971 - 6000  
Printed in Italy — Tipografia Torinese S.p.A. - Torino